



Methane to Markets

Reducing Methane Emissions with Vapor Recovery on Storage Tanks

Oil & Gas Subcommittee Technology Transfer Workshop

September 14, 2009
Calgary, Canada

Vapor Recovery Units: Agenda

- Methane Losses
- Methane Savings
- Is Recovery Profitable?
- Industry Experience
- Discussion Questions





TANK OPERATIONS

As the oil resides in the tanks, it gives off vapors, thereby increasing the pressure inside the tank.

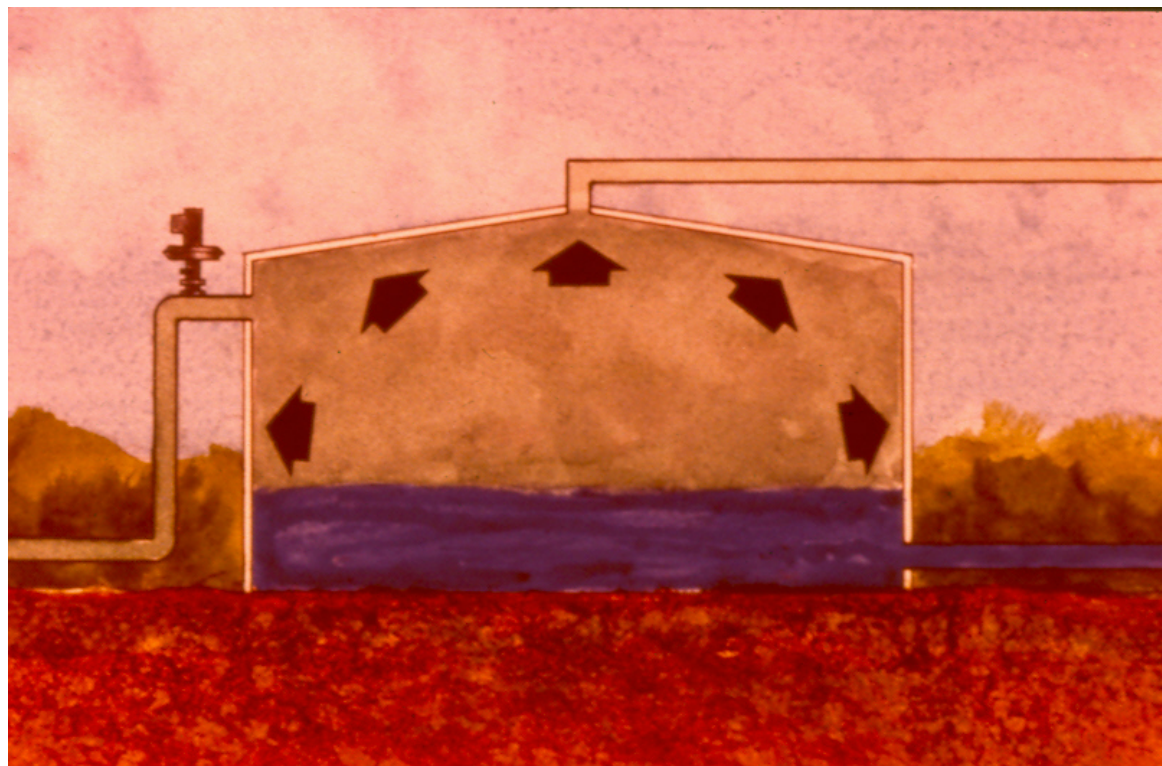

FLIR™

HI

MANUAL

WH



1/18/08 2:42:47PM



Sources of Methane Losses from Tanks

- A storage tank battery can vent 5 to 500 mcf of natural gas and light hydrocarbon vapors to the atmosphere each day
 - Vapor losses are primarily a function of oil or condensate throughput, gravity, and gas-oil separator pressure
- Flash losses
 - Occur when crude oil or condensate is transferred from a gas-oil separator at higher pressure to a storage tank at atmospheric pressure
- Working losses
 - Occur when crude or condensate levels change
- Standing losses
 - Occur with daily and seasonal temperature and barometric pressure changes

WHY LET \$ ESCAPE INTO THE AIR?

Besides being an environmental hazard, escaping vapors result in the loss of a major revenue source for the oil company. Hundreds of oil companies have added significant money to their bottom line by capturing this valuable gas stream.





Methane Savings: Vapor Recovery

- Vapor recovery can capture up to 95% of hydrocarbon vapors from tanks
- Recovered vapors have higher heat content than pipeline quality natural gas
- Recovered vapors are more valuable than natural gas and have multiple uses
 - Re-inject into sales pipeline
 - Use as on-site fuel
 - Send to processing plants for recovering valuable natural gas liquids

Types of Vapor Recovery Units

- Conventional vapor recovery units (VRUs)
 - Use special designed packages configured to capture low pressure, wet gas streams with no oxygen ingress
 - Use rotary screw or rotary vane compressor for wet gas
 - Scroll compressors are new to this market & also work well
 - Require electrical power or engine driver

- Venturi ejector vapor recovery units (EVRU™) or Vapor Jet
 - Use Venturi jet ejectors in place of rotary compressors
 - Contain no moving parts
 - EVRU™ requires a source of high pressure motive gas and intermediate pressure discharge system
 - Vapor Jet requires high pressure motive water

VAPOR RECOVERY SYSTEMS

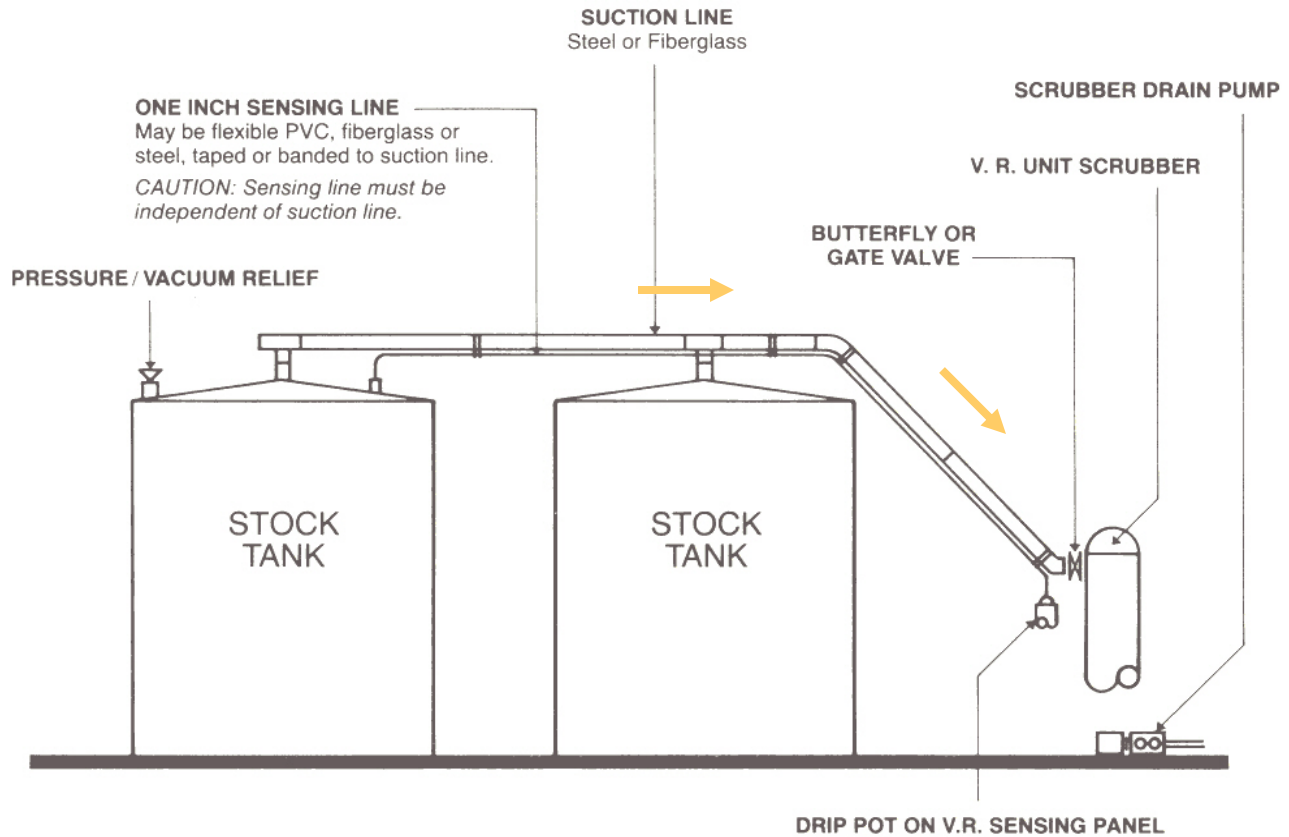

NOTES

- All lines must be horizontal, or sloped down to V.R.U. suction as shown.
- Scrubber fluid is piped back to tanks or to waste.
- The system must be closed — no air entry.

Conventional Vapor Recovery Unit

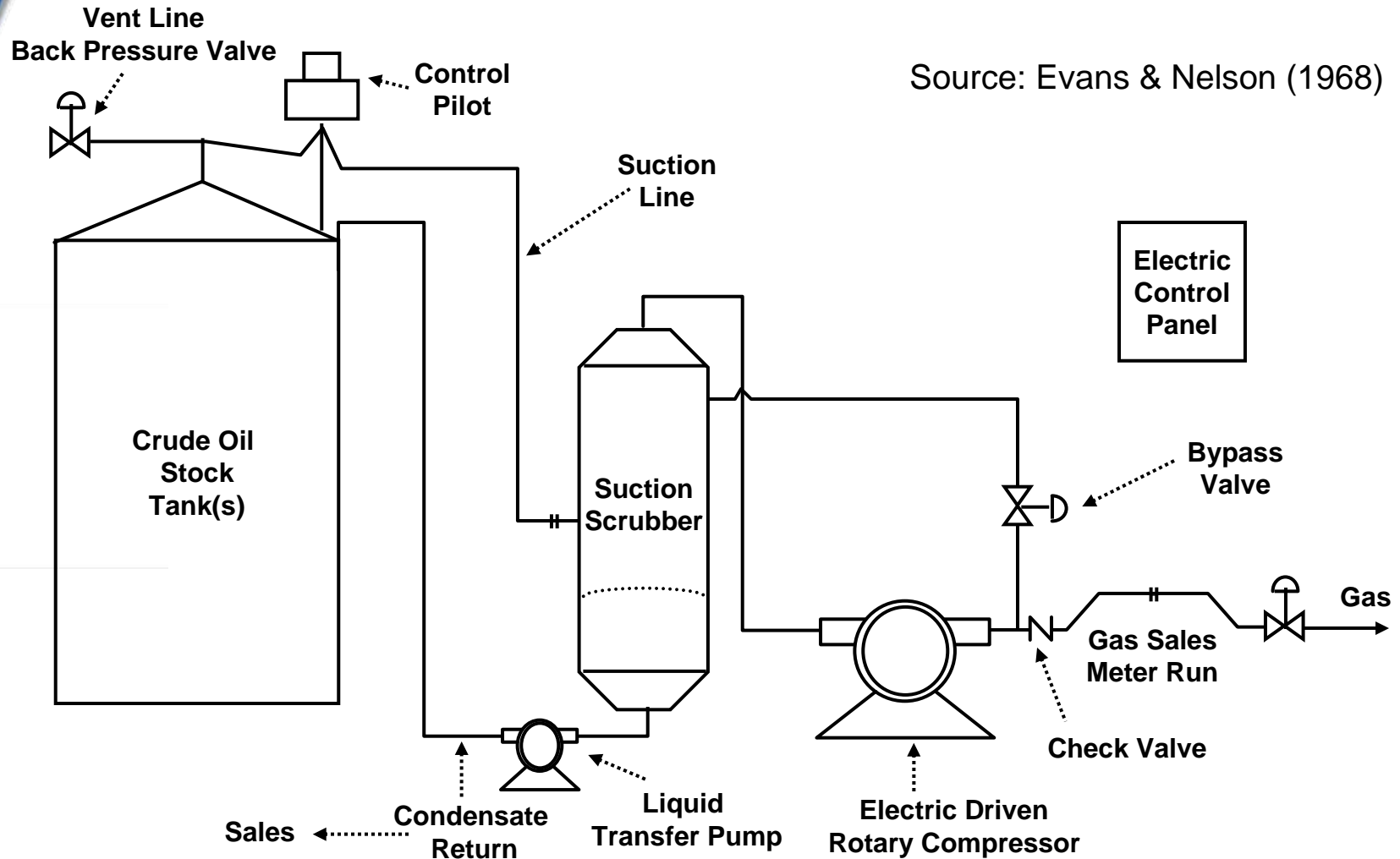

Source: Evans & Nelson (1968)

Rotary Vane VRU's



Rock Springs, Wyoming
Rotary Vane VRU Installation
Used in VRU svc for 50+ years
Photos Courtesy of Hy-bon Engineering

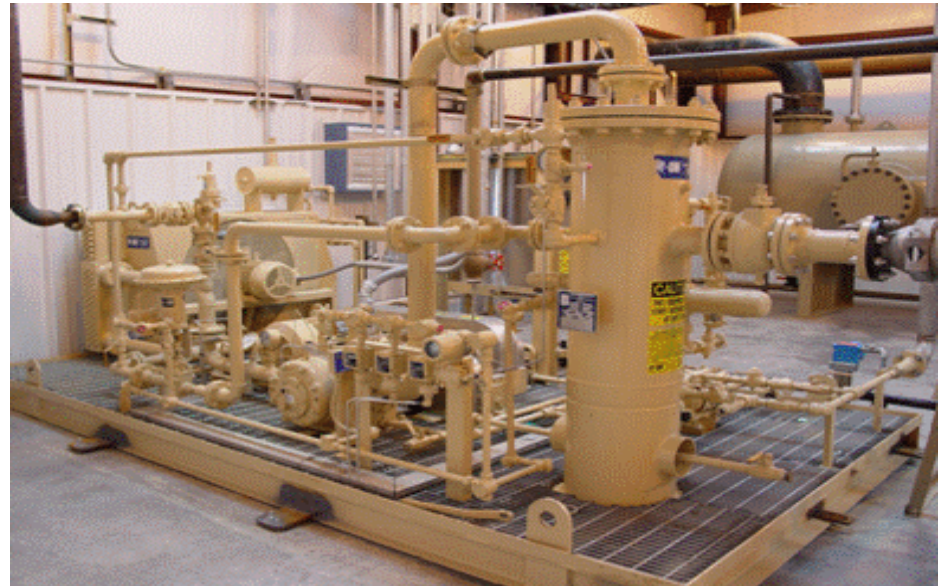

Rotary Screw VRU's

Eni installed vapor recovery systems in their Dacion East and West facilities in Venezuela, each designed to move 1.4 MMSCFD of gas at pressures to 230 psig.



Eni Oil & Gas Dacion
Field, Venezuela; 2004

Rotary Screws used in
VRU Svc for 15+ years

Project Overview – Eni Dacion (Venezuela)

- Rotary Screw Vapor recovery units were installed to capture up to 1.4 MMCFD per site
- White paper was written shortly after installation on the economic success of the project; denoting economic payback of less than 12 months
- A highly valuable 70 API gravity condensate was recovered from the gas stream and used to blend with the primary low API gravity oil production – at an approximate daily rate of 100 to 150 barrels of condensate per unit.

Scroll VRU's

- Scroll compressors 1st used in VRU's in 2004
- Over 70 now installed in U.S. in VRU service
- Devon case study using scrolls in STAR website



Scroll VRU Installation

Courtesy of Hy-bon Engineering

Venturi Jet Ejector*

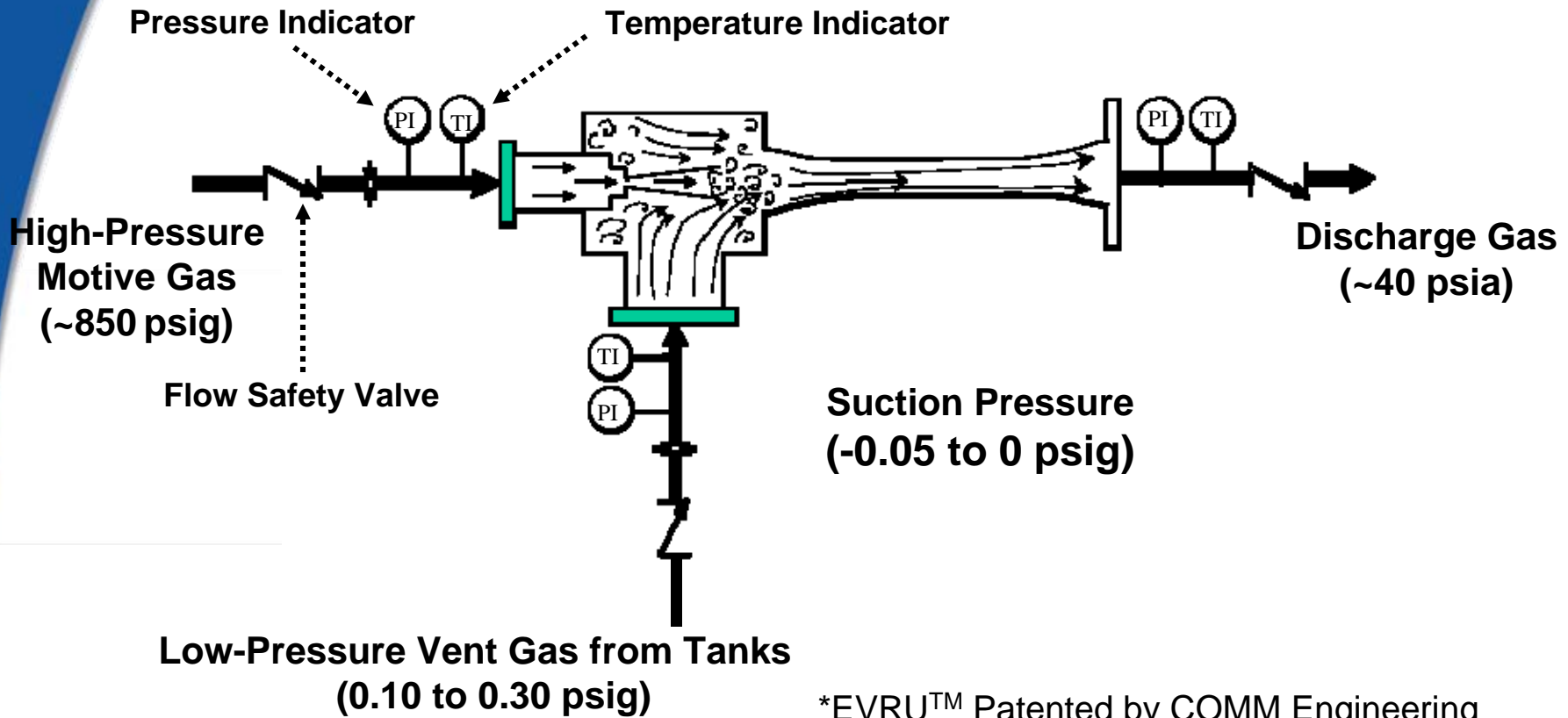

*EVRU™ Patented by COMM Engineering
Adapted from SRI/USEPA-GHG-VR-19
psig = pound per square inch, gauge
psia = pounds per square inch, absolute

Vapor Recovery with Ejector

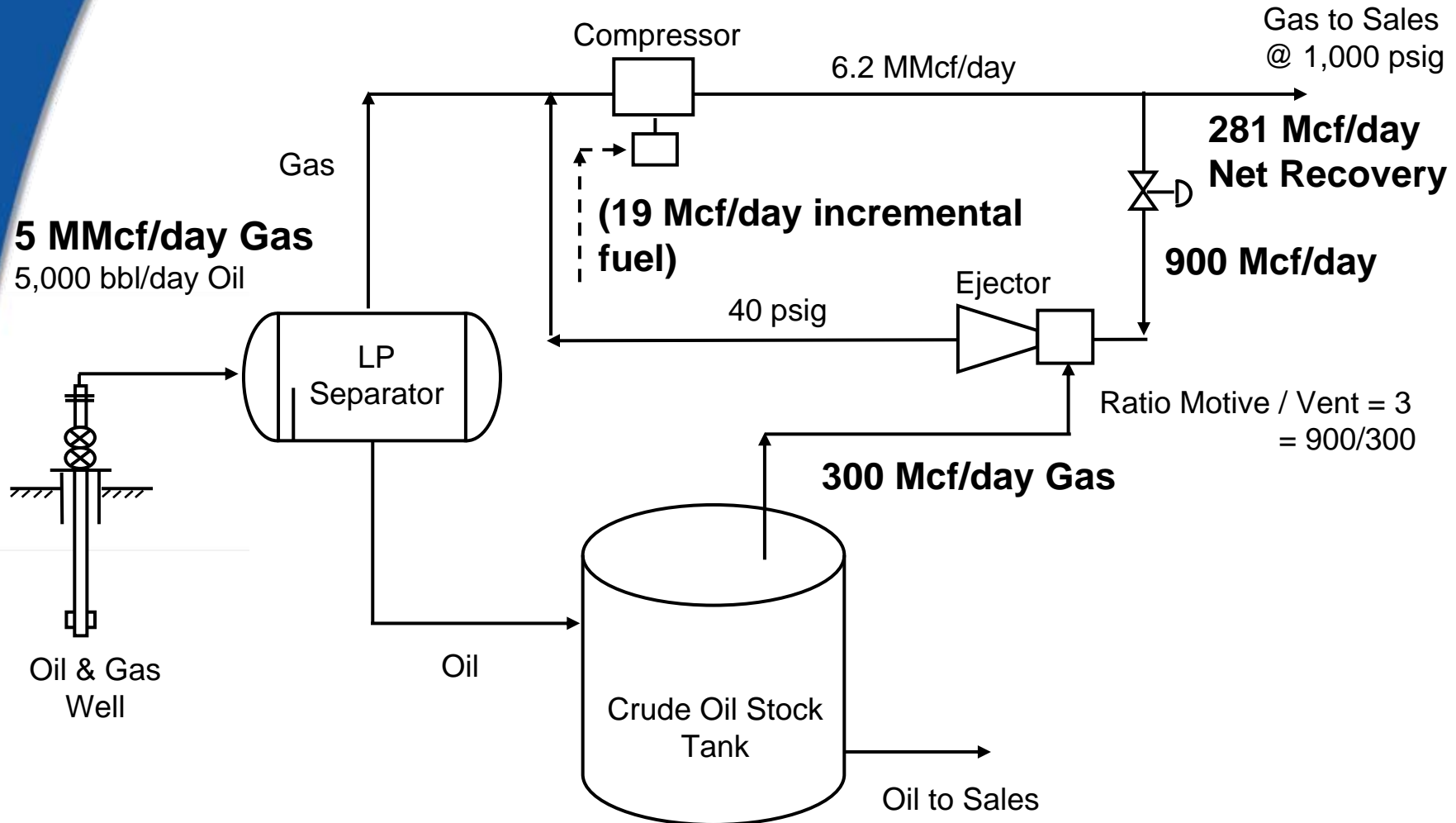

Vapor Jet System*

JET PUMP DESIGN

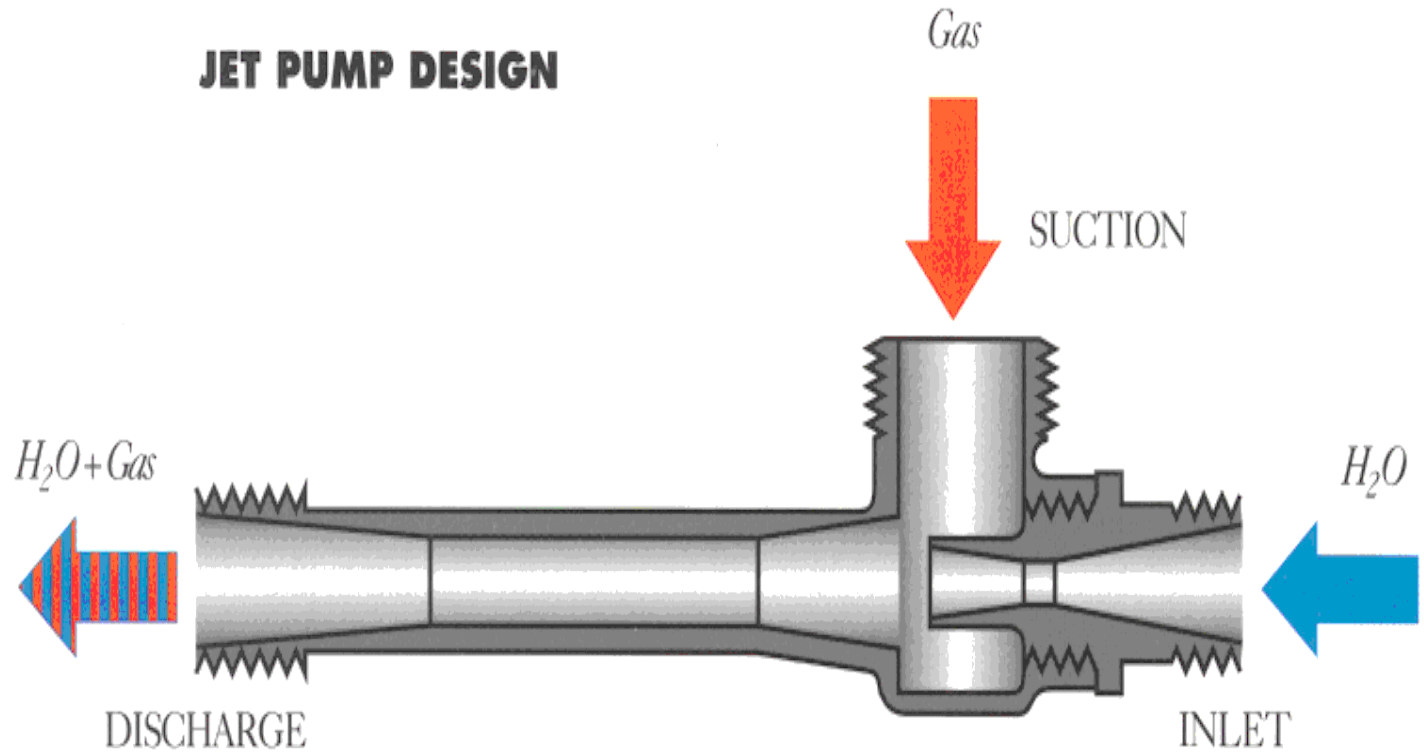

*Patented by Hy-Bon Engineering

Vapor Jet System*

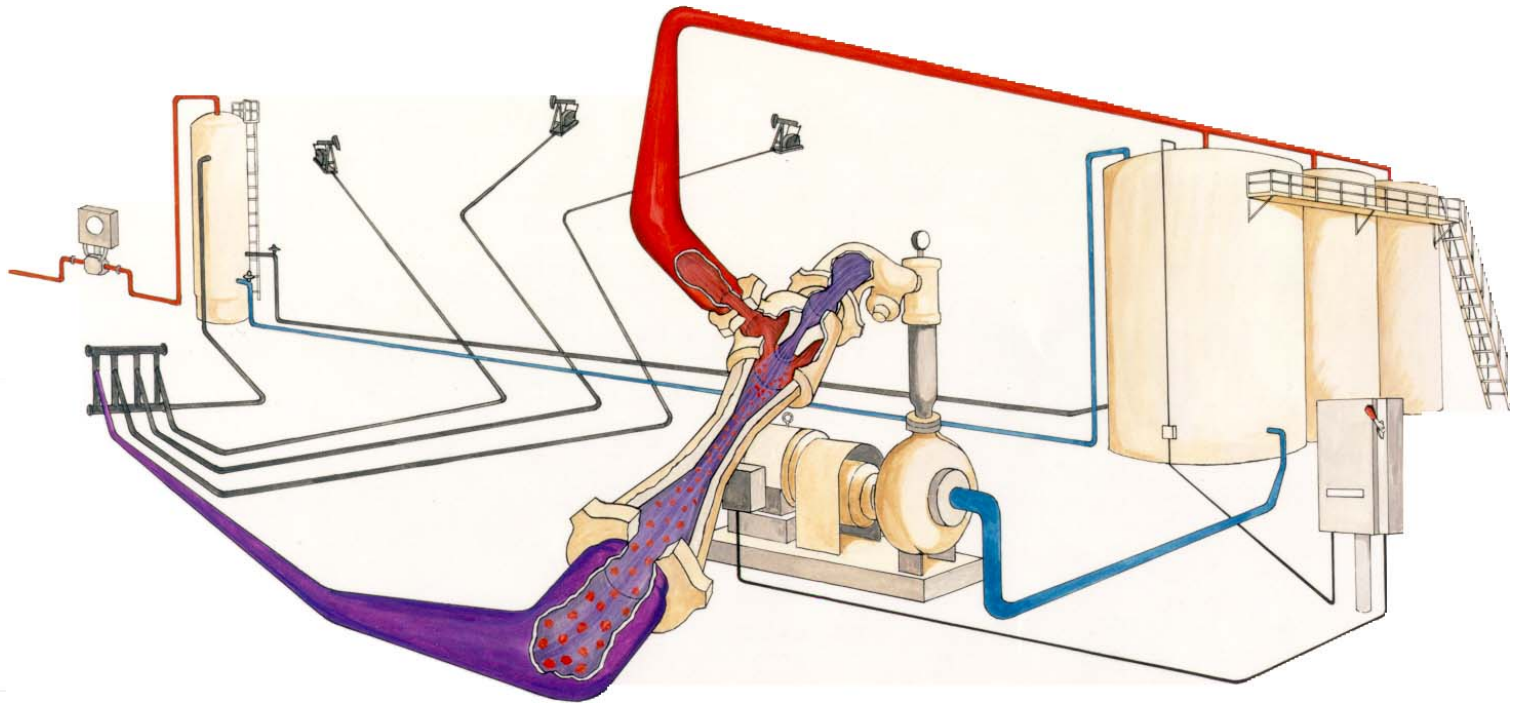

- Utilizes produced water in closed loop system to effect gas gathering from tanks
- Small centrifugal pump forces water into Venturi jet, creating vacuum effect
- Limited to gas volumes of 77 Mcf/day and discharge pressure of 40 psig

*Patented by Hy-Bon Engineering

Criteria for Vapor Recovery Unit Locations

- Steady source and sufficient quantity of losses
 - Crude oil stock tank
 - Flash tank, heater/treater, water skimmer vents
 - Gas pneumatic controllers and pumps
 - Dehydrator still vent
 - Pig trap vent
- Outlet for recovered gas
 - Access to low pressure gas pipeline, compressor suction, or on-site fuel system

Quantify Volume of Losses

- Estimate losses from chart based on oil characteristics, pressure, and temperature at each location ($\pm 50\%$)
- Estimate emissions using the E&P Tank Model ($\pm 20\%$)
- Engineering Equations – Vasquez Beggs ($\pm 20\%$)
- Measure losses using recording manometer, turbine meter or ultrasonic meter over several cycles ($\pm 5\%$)
 - This is the best approach for facility design

Estimated Volume of Tank Vapors

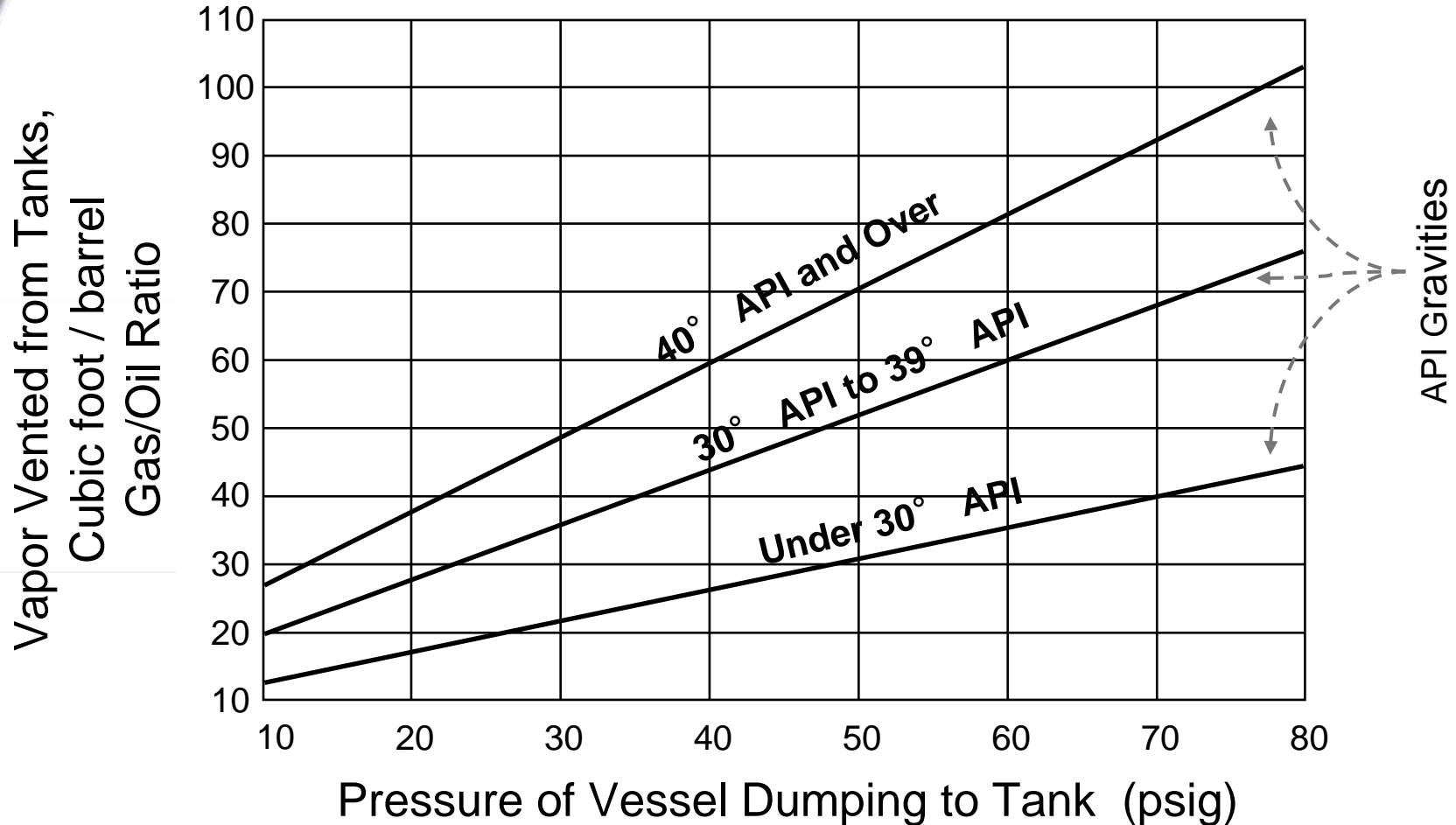

° API = API gravity



What is the Recovered Gas Worth?

- Value depends on heat content of gas
- Value depends on how gas is used
 - On-site fuel
 - Valued in terms of fuel that is replaced
 - Natural gas pipeline
 - Measured by the higher price for rich (higher heat content) gas
 - Gas processing plant
 - Measured by value of natural gas liquids and methane, which can be separated
- Gross revenue per year = $(Q \times P \times 365) + \text{NGL}$
 - Q = Rate of vapor recovery (MMBtu per day)
 - P = Price of natural gas (US\$/MMBtu)
 - NGL = Value of natural gas liquids

Value of Natural Gas Liquids

NGL Components	1 Btu/gal	2 MMBtu/gal	3 US\$/gal	4 US\$/MMBtu ^{1,2} (=3/2)
Methane	59,755	0.060	0.30	5.00
Ethane	74,010	0.074	0.26	3.45
Propane	91,740	0.092	0.45	5.09
n Butane	103,787	0.104	0.49	4.91
iso Butane	100,176	0.100	0.53	5.44
Pentanes+	105,000	0.105	0.57	5.27

	5 Btu/cf	6 MMBtu/Mcf	7 US\$/Mcf (=4*6)	8 US\$/MMBtu	9 Vapor Composition	10 Mixture (MMBtu/Mcf)	11 Value (US\$/Mcf) (=8*10)
Methane	1,000	1.000	\$5.00	\$5.00	82%	0.82	\$4.10
Ethane	1,773	1.773	\$6.12	\$3.45	8%	0.14	\$0.49
Propane	2,524	2.524	\$12.86	\$5.09	4%	0.10	\$0.51
n Butane	3,271	3.271	\$16.05	\$4.91	3%	0.10	\$0.48
iso Butane	3,261	3.261	\$17.74	\$5.44	1%	0.03	\$0.18
Pentanes+	4,380	4.380	\$23.06	\$5.27	2%	0.09	\$0.46
Total						1.28	6.22

1 – Natural Gas price assumed at Mexico's cost US\$5/MMBtu

2 – Prices of Individual NGL components estimated based on natural gas price in Mexico.

Is Recovery Profitable?

Financial Analysis for a Conventional VRU Project

Peak Capacity (Mcf/day)	Installation & Capital Costs ¹ (US\$)	O&M Costs (US\$/year)	Value of Gas ² (US\$/year)	Annual Savings (US\$)	Simple Payback (months)	Internal Rate of Return %
25	35,738	7,367	28,398	21,031	20	51
50	46,073	8,419	56,795	48,376	11	102
100	55,524	10,103	113,590	103,487	6	185
200	74,425	11,787	227,181	215,394	4	289
500	103,959	16,839	567,952	551,113	2	530

1 - Unit cost plus estimated installation of 75% of unit cost

2 - US\$6.22 x ½ peak capacity x 365, Assumed price includes enriched gas

Industry Experience: EnCana Oil & Gas

- Vapor recovery unit installed in Frenchie Draw, WY, U.S.
- Captures vapors from
 - Separators
 - Crude oil storage tank
 - Non-condensable dehydrator still gas
- VRU designed to handle 500 Mcf/day
 - Additional capacity over the estimated 284 Mcf/day of total gas from all emission sources

Industry Experience: EnCana Oil & Gas

- Quantify the volume of vapor emissions

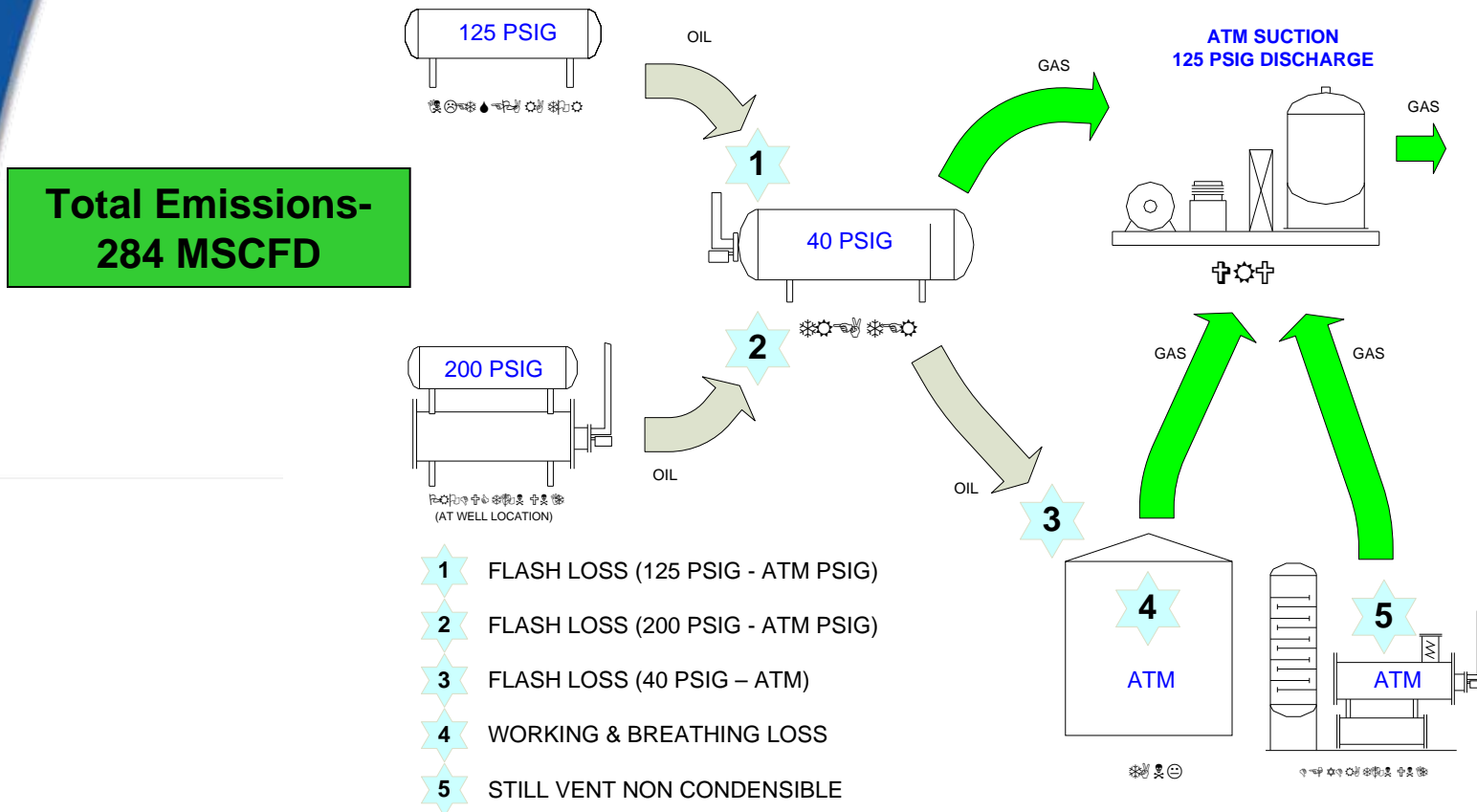

Source: EnCana Oil & Gas (USA) Inc.

EnCana Oil & Gas: Project Costs

- Determine the cost of VRU project

Installation (US\$)

VRU Unit (500 Mcfd) -	90,000
Generator-	85,000
Vent Header-	25,000
Labor-	<u>200,000</u>
TOTAL	400,000

O & M (US\$)

VRU Unit (500 Mcfd) -	15,000
Generator-	18,000
Fuel-	<u>73,000</u>
TOTAL	106,000

EnCana Oil & Gas: Project Economics

- Evaluate VRU economics

Capacity–	500 Mcfd
Installation Cost -	US\$400,000
O&M-	US\$106,000/year
Value of Gas*-	US\$515,594/year

Gas Price (US\$/MMBtu)	3	5	7
Payback (months)	24	12	8
NPV (US\$)	281,682	973,023	1,664,364

*Conservatively based on natural gas price assumed to be US\$5/MMBtu
and 1 Mcf = 1 MMBtu

Industry Experience: Anadarko

- Vapor Recover Tower (VRT)
 - Add separation vessel between heater treater or low pressure separator and storage tanks that operates at or near atmospheric pressure
 - Operating pressure range: 1–5 psig
 - Compressor (VRU) is used to capture gas from VRT
 - Oil/Condensate gravity flows from VRT to storage tanks
 - VRT insulates the VRU from gas surges with stock tank level changes
 - VRT more tolerant to higher and lower pressures
 - Stable pressure allows better operating factor for VRU

VRT/VRU Photos



Courtesy of Anadarko

Industry Experience: Anadarko

- VRT reduces pressure drop from approximately 50 psi to 1–5 psi
 - Reduces flashing losses
 - Captures more product for sales
 - Anadarko netted between US\$7 to US\$8 million from 1993 to 1999 by utilizing VRT/VRU configuration
- Equipment Capital Cost: \$11,000 (VRT cost only)
- Standard size VRTs available based on oil production rate
 - 20" x 35'
 - 48" x 35'
- Anadarko has installed over 300 VRT/VRUs since 1993 and continues on an as needed basis

Industry Experience: ConocoPhillips

- Vapor recovery units installed in Baker, MT
- Anticipated multiple sites, so detailed technical review of options was conducted
- Volumes per site ranged from 30 mcf/d to 350 mcf/d
- Pipeline pressure ranged from 20 to 40 psig
- Captures vapors from
 - Crude oil storage tanks
 - Produced Water tanks
 - All manifolded together in closed loop system
 - Gas blanket system used to backfill tanks

Industry Experience: ConocoPhillips

- Evaluated rotary screw, rotary vane, vapor jet and EVRU
- Selected rotary vane VRU's due to wide range of volumes of gas and low discharge pressure across the sites
- Pilot project on 3 locations, then added 6 addt'l sites
- Designed for optimum gas capture
 - Pressure transmitter on the tanks
 - Sloping lines to the VRU
 - Package specifically designed for vapor recovery service
 - Automated liquid handling and bypass systems



Baker, MT ConocoPhillips VRU installation; Picture Courtesy of Hy-bon Engineering



Baker, MT ConocoPhillips VRU installation; Picture Courtesy of Hy-bon Engineering



Baker, MT ConocoPhillips VRU installation; Picture Courtesy of Hy-bon Engineering



Baker, MT ConocoPhillips VRU installation; Picture Courtesy of Hy-bon Engineering

Industry Experience: ConocoPhillips

- Payback Economics – Project for 9 Tank Batteries
 - Purchase Price for 9 VRU's \$475,000
 - Estimate Install Cost \$ 237,500
 - Total Capital Costs \$ 712,500

- Approx Gas Revenue
 - 1,050 mcf/d x \$6/mcf (2005 & 6) X 30 days = \$189,000/ mo

 - Payback on Capital Investment < 4 months

 - Installed in 2005 & early 2006 – all locations continue to generate incremental revenue and meet environmental compliance goals today

Lessons Learned

- Vapor recovery can yield generous returns when there are market outlets for recovered gas
 - Recovered high heat content gas has extra value
 - Vapor recovery technology can be highly cost-effective in most general applications
 - Venturi jet models work well in certain niche applications, with reduced operating and maintenance costs
- Potential for reduced compliance costs can be considered when evaluating economics of VRU, EVRU™, or Vapor Jet

Lessons Learned (continued)

- VRU should be sized for maximum volume expected from storage tanks (rule-of-thumb is to double daily average volume)
- Rotary vane, screw or scroll type compressors recommended for VRUs where Venturi ejector jet designs are not applicable
- EVRU™ recommended where there is a high pressure gas compressor with excess capacity
- Vapor Jet recommended where there is produced water, less than 75 Mcf per day gas and discharge pressures below 40 psig

