



Universidade Federal do Rio de Janeiro
Escola Politécnica, Depto. de Recursos Hídricos e Meio Ambiente

COGENERATION OF ELECTRICAL AND THERMAL ENERGY FROM BIOGAS IN WASTEWATER TREATMENT PLANTS THE CASE OF BRAZIL

Eduardo Pacheco Jordão, Dr. Eng.

VENICE, 2010



Brazil and Latin America



Brazil

Area: 8,6 million km²

Population: 187 million

Water Supply: ~ 95% *

Sewerage: ~ 51% *

Wastewater treatment: ~ 35% **

- * % of the urban population
- ** % of the sewer system = ~17% of the urban pop.



Sanitation in Brazil

Population → Total - % Urban - %

Water Supply 81.2 94.7

Sewerage 43.2 50.6

Wastewater Treatment 34.6 *

(*) = 17% of the urban pop., SNIS, 2008



Infant Mortality – Year 2010

Wealthy countries

- Sweden - 2.7
- Japan - - - 2.7
- Italy - - - - 3.3
- Norway - - 3.4
- France - - 3.8
- UK - - - - - 5.3
- USA - - - - - 6.7

Developing countries

- Cuba - - - - 5.2
- Chile - - - - 6.5
- Argentina -12.8
- China - - - 15.4
- Colombia- 15.3
- Mexico - - 16.5
- Brazil - - - 19.9

Very poor countries

- Chade - - 114.4
- G.Bissau 158.6
- Mali - - - 161.0
- Nigeria - 168.7
- Angola - 180.2



Health & Sanitation

- Year Infant Mortality in Brazil
 - 1970 120,7 /1000 born, under 1 year old
 - 1990 52,0
 - 2010 19,9
-
- Brazil should meet the millenium goal



The Urban Challenge

Materials

Food

Energy

Water

Chemicals



Wastewater

**Emissions CO₂
NO_x SO₂**

Solid Wastes



The Urban Challenge



Materials

Food

Energy

Water

Chemicals



Wastewater

Emissions CO₂
NO_x SO₂

Solid Wastes



Recycle - Reuse - Treat



The Urban Challenge



Materials

Food

Energy

Water

Chemicals



Wastewater

Emissions CO₂
NO_x SO₂

Solid Wastes



Recycle - Reuse – Treat – Recover Energy



Challenge – Wastewater Treatment

- Enormous advancement in wastewater technology in Brazil
- Economical processes for wastewater treatment have been well established
- There is a good Brazilian experience with new and applicable technology
- How experts, federal and state agencies are facing the question ?



Investigation & Research Funding Water Utilities

- ✓ FINEP, a governmental organization, under Ministry of Science and Technology;
- ✓ Has been financing a special research program on wastewater treatment since 1996; specially on anaerobic processes;
- ✓ 15 universities form the research network



Wastewater Treatment Research Center, UFRJ



UASB = Upflow Anaerobic Sludge Blanket Reactor

One of the new economical processes
developed for WWTP.

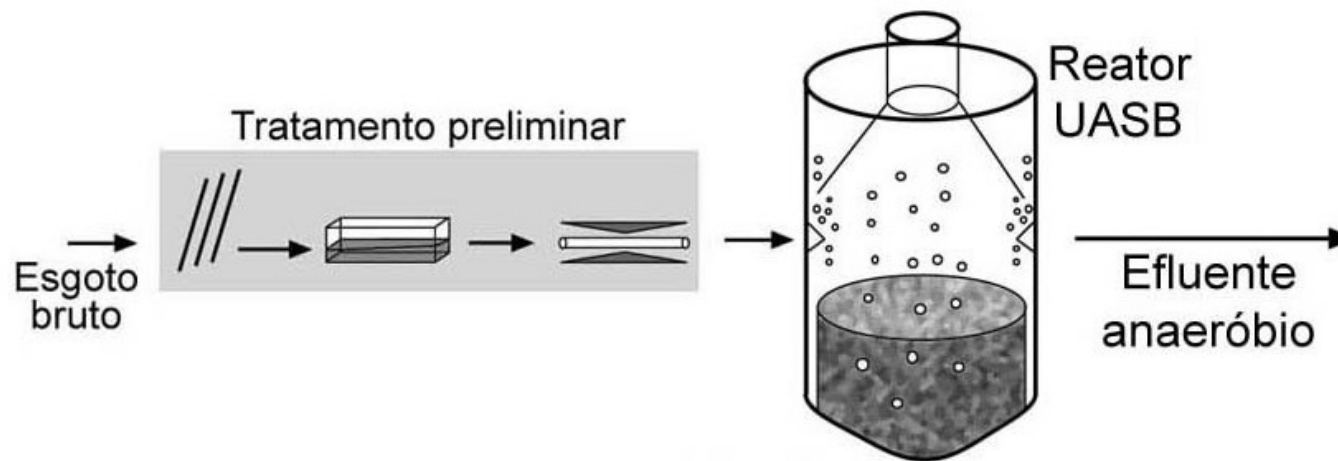

UASB

Influent

UASB Effluent

Biogas
acumulation

Phase
separator

Influent
flow pipes

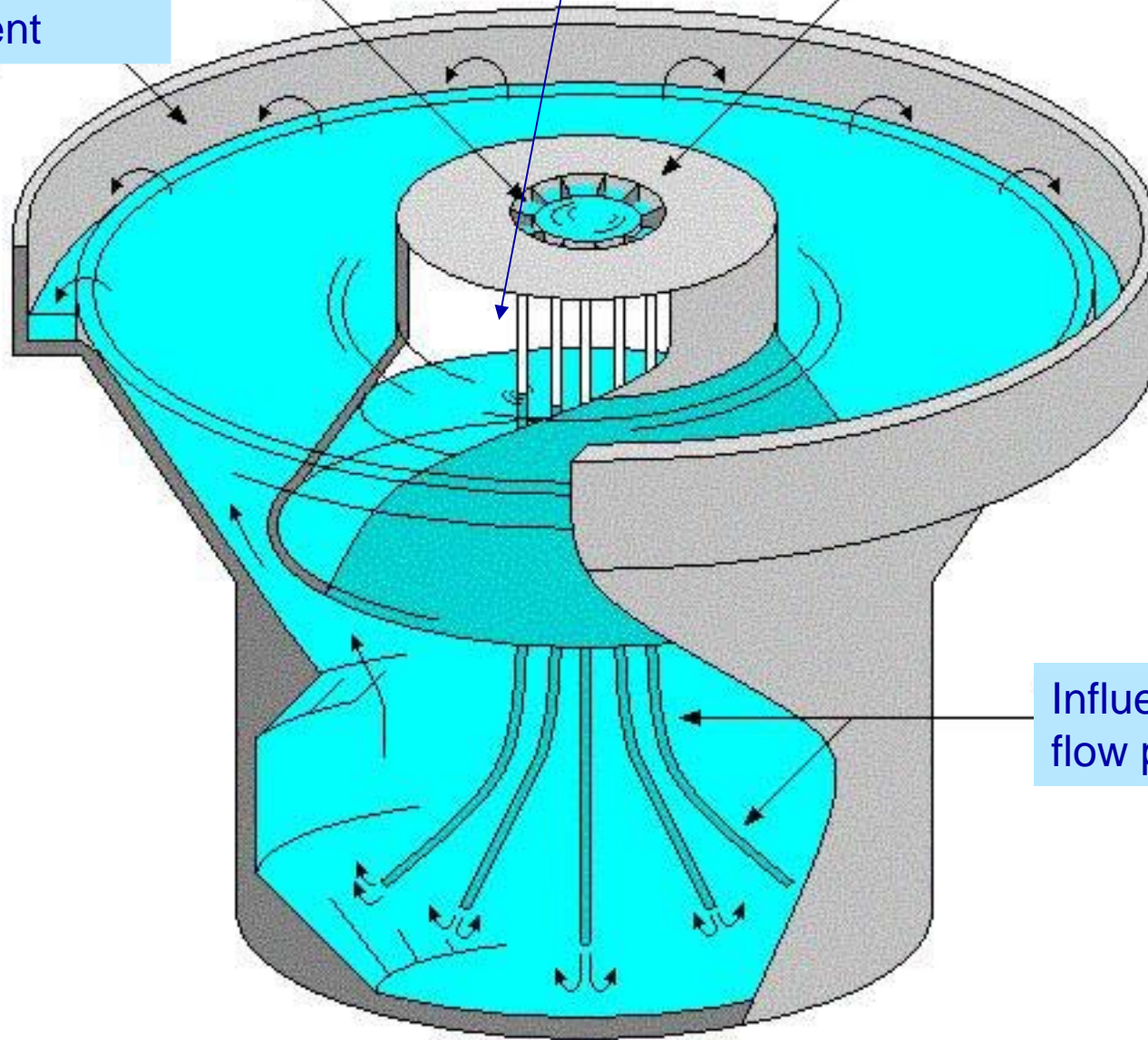

UASB

- compact system, using a small surface area;
- ✓ practically no equipment in the anaerobic process, with low construction and operational costs;
- ✓ very low energy consumption;
- ✓ low excess sludge produced;
- ✓ **INTENSE BIOGAS PRODUCTION.**



UASB + Activated Sludge

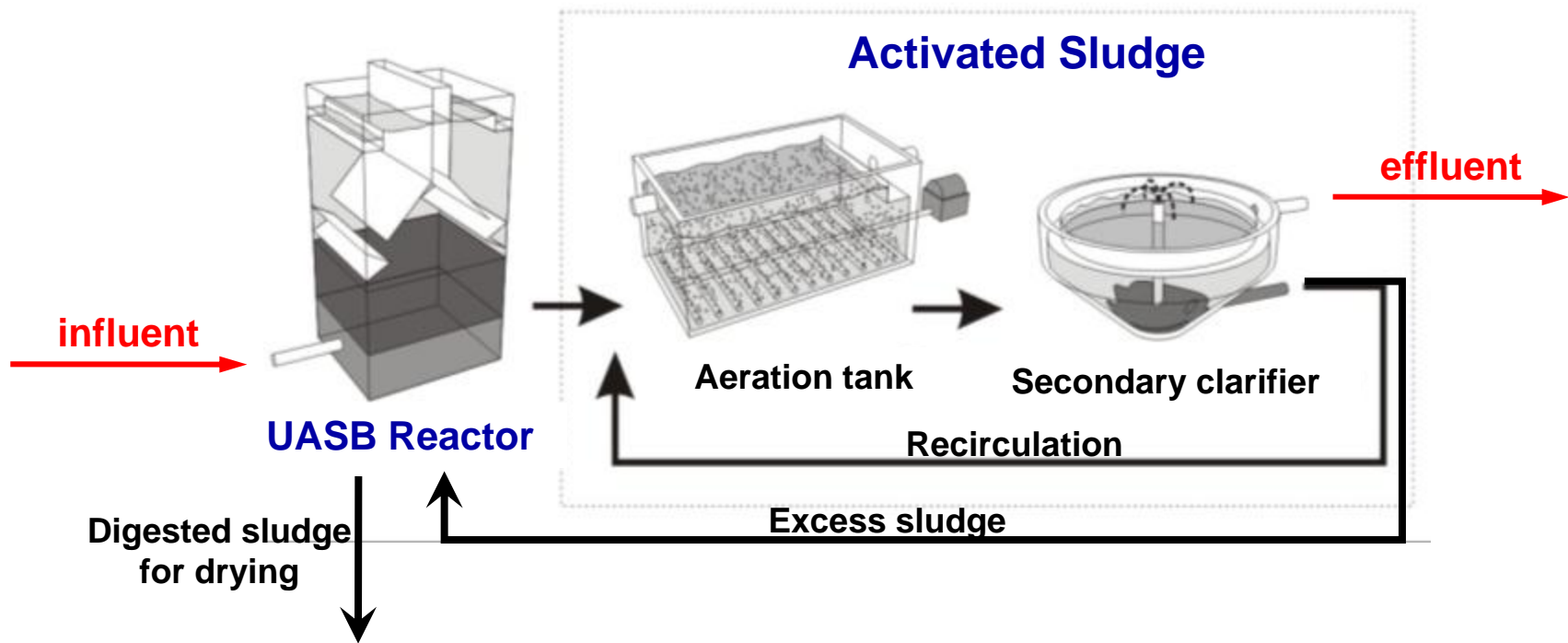

UASB Reactors + Posttreatment

Possibility of Energy Recovery
from the Biogas produced



A new design

Clarifiers + second. treat.

UASB + secondary treat.

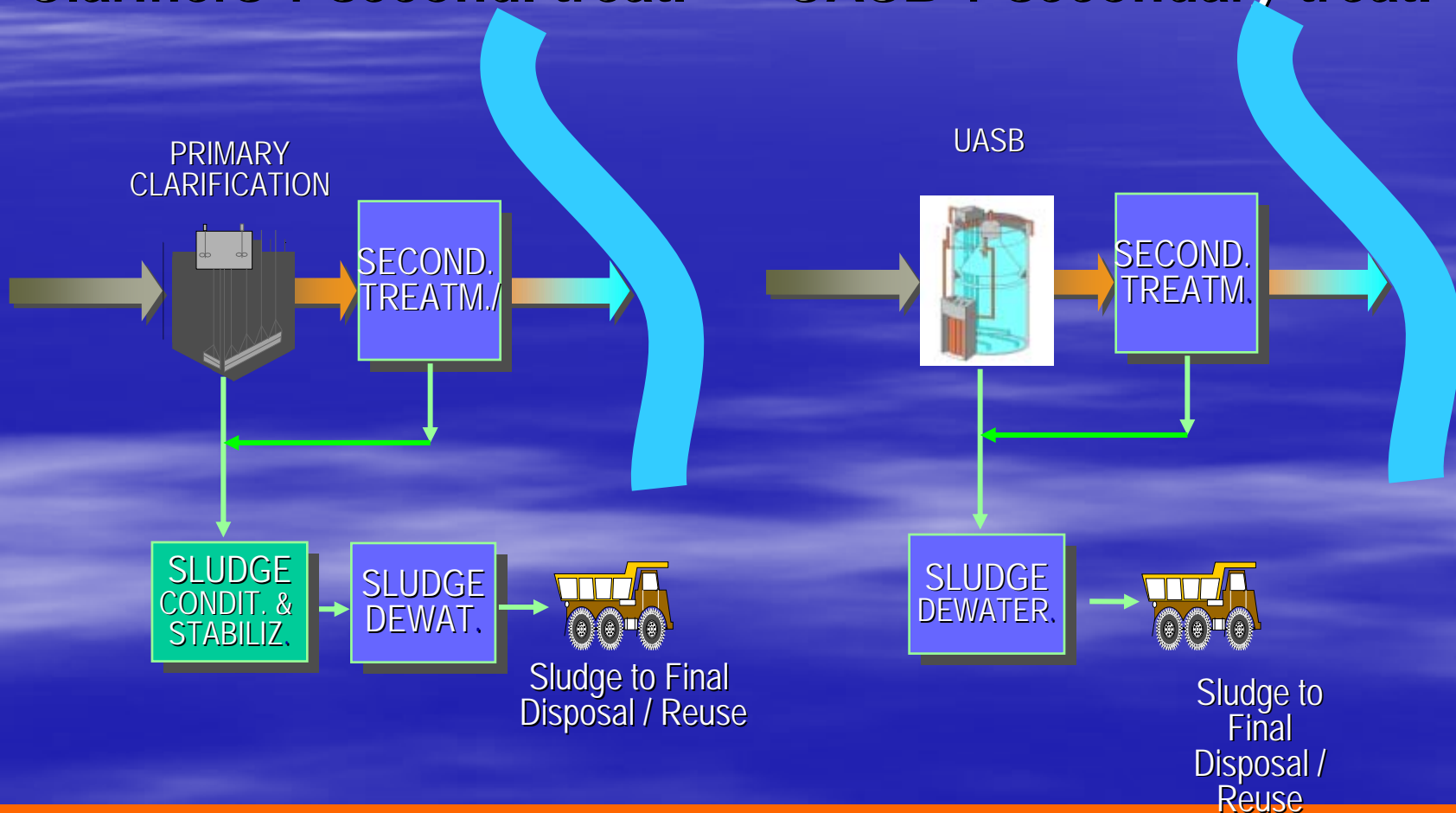

UASB IN BRAZIL

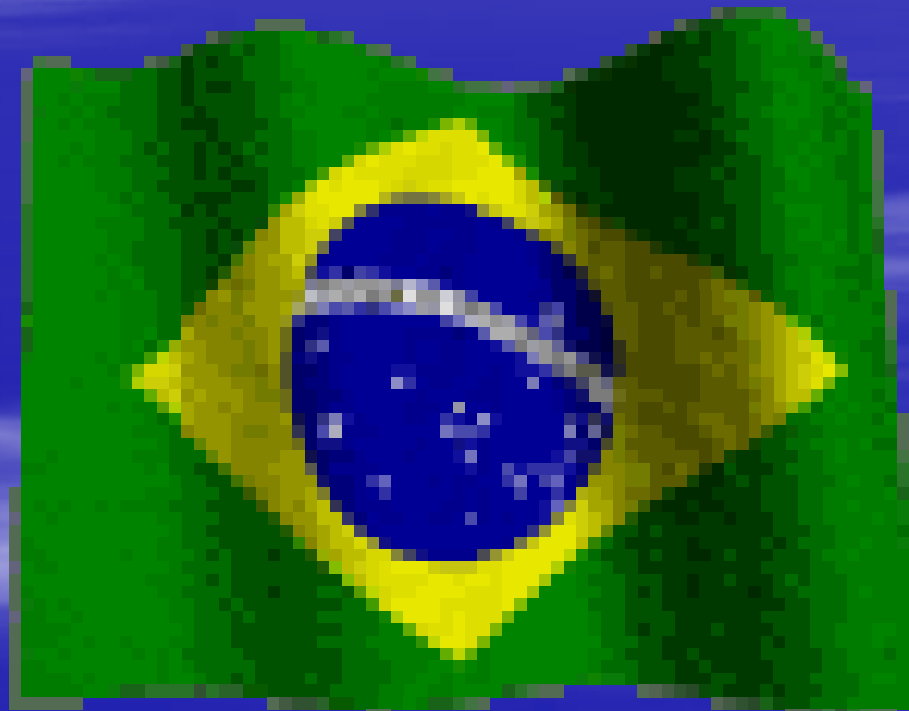

S.Jorge WWTP – Alm. Tamandaré 20,000 inhab.



Cambuí WWTP - Campo Largo, 30,000



Barreto WWTP – Niterói, 60,000



Rio das Ostras WWTP – 150,000



Sul WWTP – Londrina, 225,000



Piçarrão WWTP – Campinas, 250,000



Gama WWTP – Brasília, 300,000



Atuba Sul WWTP – Curitiba - 580,000



Onça WWTP – Belo Horizonte 1,500,000



Yes – we can !

- We can afford adjusting our technology for our own conditions
- We can afford building cost-effective WWTP
- We can win the challenge of poverty, of public health, of water management, of environmental protection
- We can produce biosolids for agriculture
- **We can recover energy from our WWTP**
- **We can manage a sustainable sanitation program**



Burning gas x Energy recovery



Conversion of Volatile Solids into Methane Gas

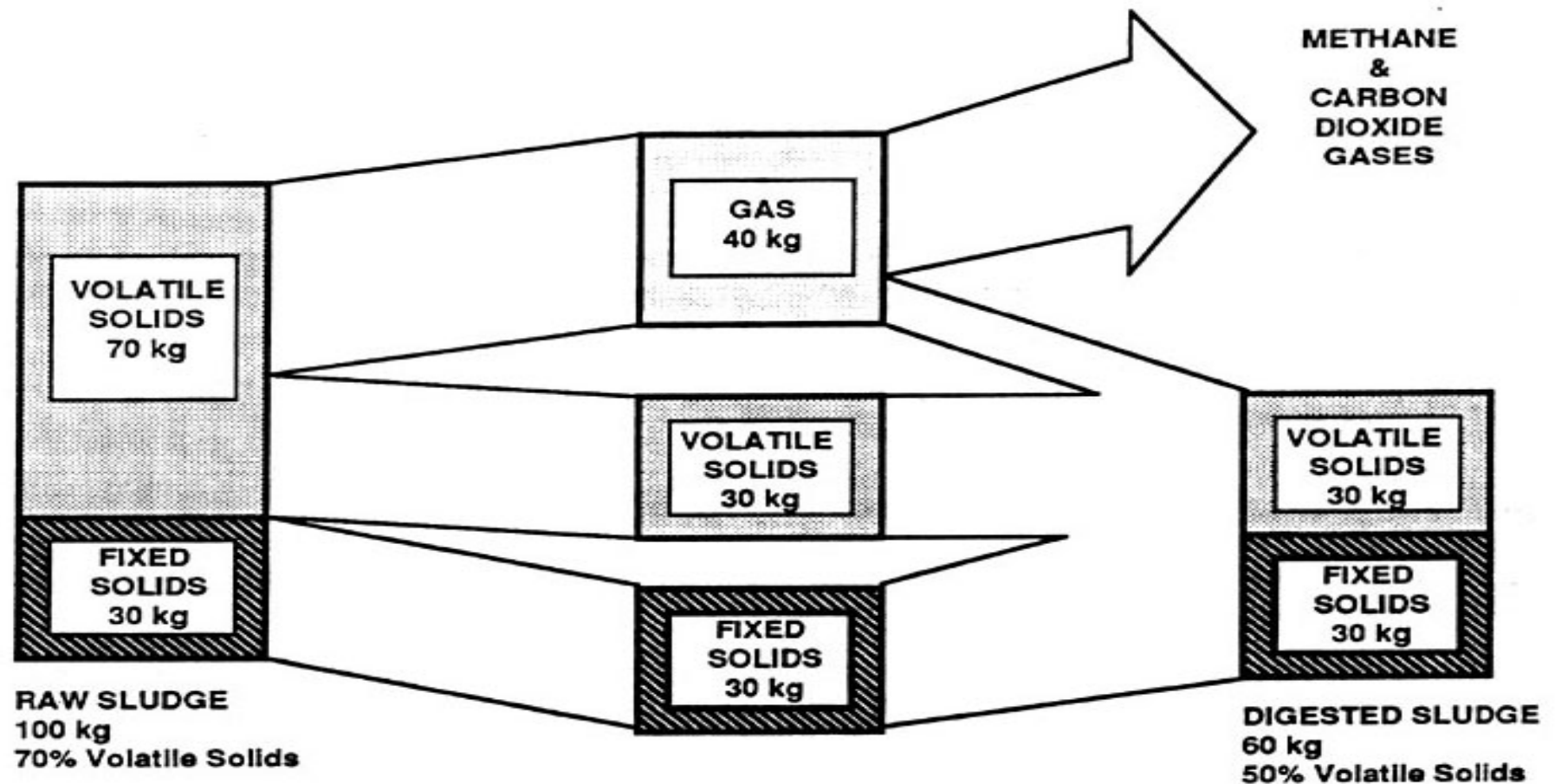

Energy Recovery

<u>Gás</u>	<u>Heat Power, kJ/m³</u>
■ Propane (comercial)	45,800
■ Butane (comercial)	44,600
■ Natural gas	37,300
■ Methane	35,800
■ Digestion gas (*)	22,400

(*) For 65% methane in the biogas



Energy Recovery

- Heat power (biogas) = 22,400 kJ/m³
- 5 to 20 L gas/person.day (conv. plant)
- For a 200,000 people Conv. Plant (*):
 - $0.020 \times 200,000 = 2,000 \text{ m}^3 \text{ biogas/day}$
 - $2,000 \times 22,400 = 4.5 \times 10^7 \text{ kJ/d} = 1.6 \times 10^{10} \text{ kJ/y}$
 - = **$4.6 \times 10^6 \text{ kWh/y}$**

(*) with the maximum gas production



Energy consumption at the WWTP

Typical WWTP uses ~ 1,200 kWh/MG treated

- Aeration = 52%
- Solids processing = 30%
- Influent pumping = 12%
- Internal recycle pumping = 3%
- Nutrient removal generally increases overall energy costs



Energy consumption at the WWTP

- 200,000 people
- X 40 gal/hab.d = 8 MGD = 2,920 MGY
- Consumption Rate ~ 1,200 kWh/MG treated
- Energy Use ~ $2920 \times 1200 = 3.5 \times 10^6$ kWh/y
- Production, max.gas rate ~ 4.6×10^6 kWh/y
- Production, avg.gas rate ~ 2.3×10^6 kWh/y
- Production, min.gas rate ~ 1.2×10^6 kWh/y



Does it pay off ???

- Costs of
 - Investments (Equipments & Construction)
 - Energy (Demand & Consumption)

- Feasibility

- Plant flow, local aspects



Energy recovery at conventional WWTP

- Electrical energy
- Thermal energy
- Heat exchangers
- Fuel for thermal sludge driers

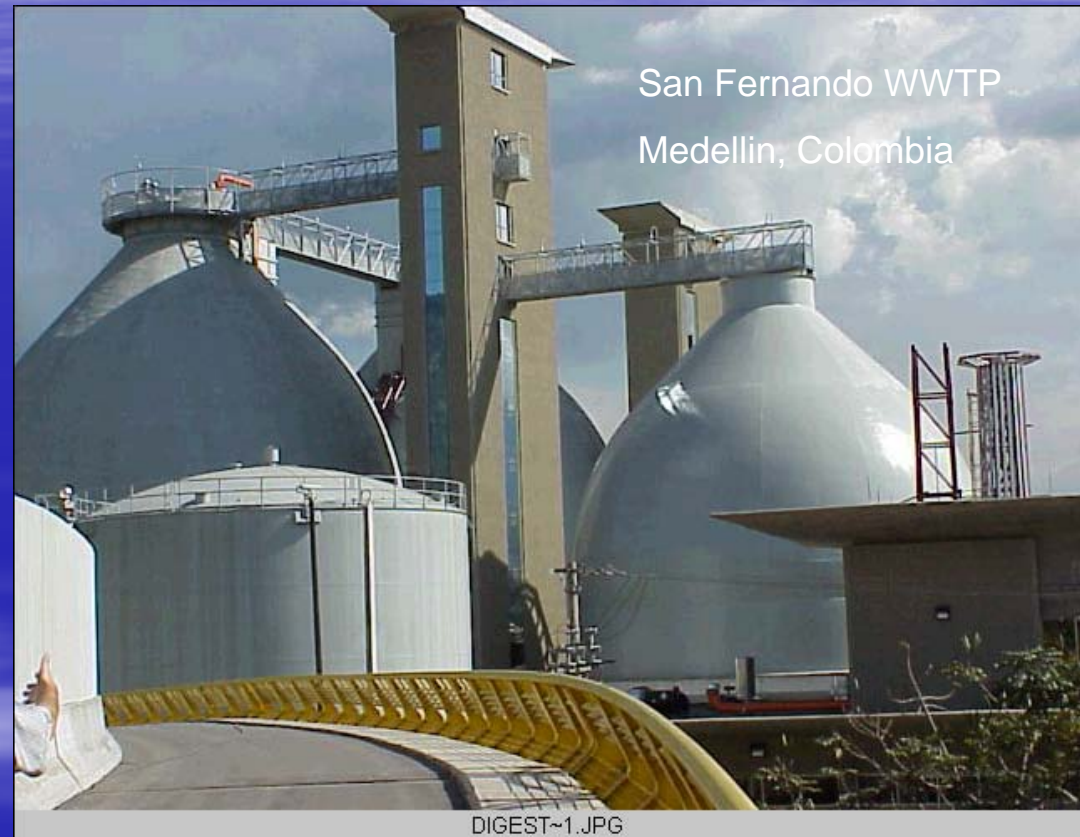



San Fernando WWTP
Medellin, Colombia

San Fernando WWTP, energy recovery

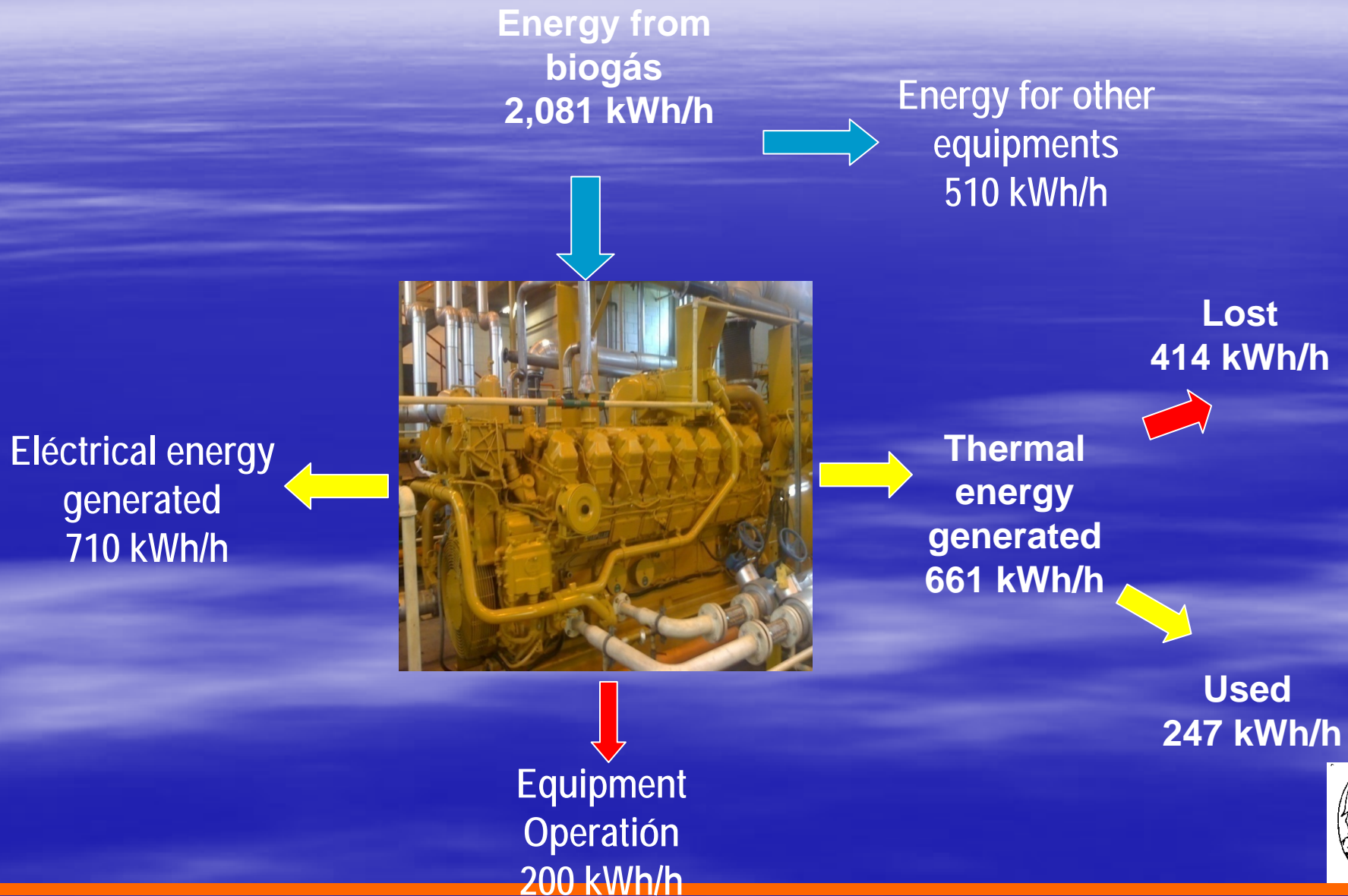

Along the 7 first years of operation the San Fernando WWTP produced 25,000,000 m³ biogás (65% CH₄ y 33% CO₂), or 52,000 ton CO₂ e/year



Bello WWTP, Medellin, Colombia

Digestors

Gas holders

Energy motors

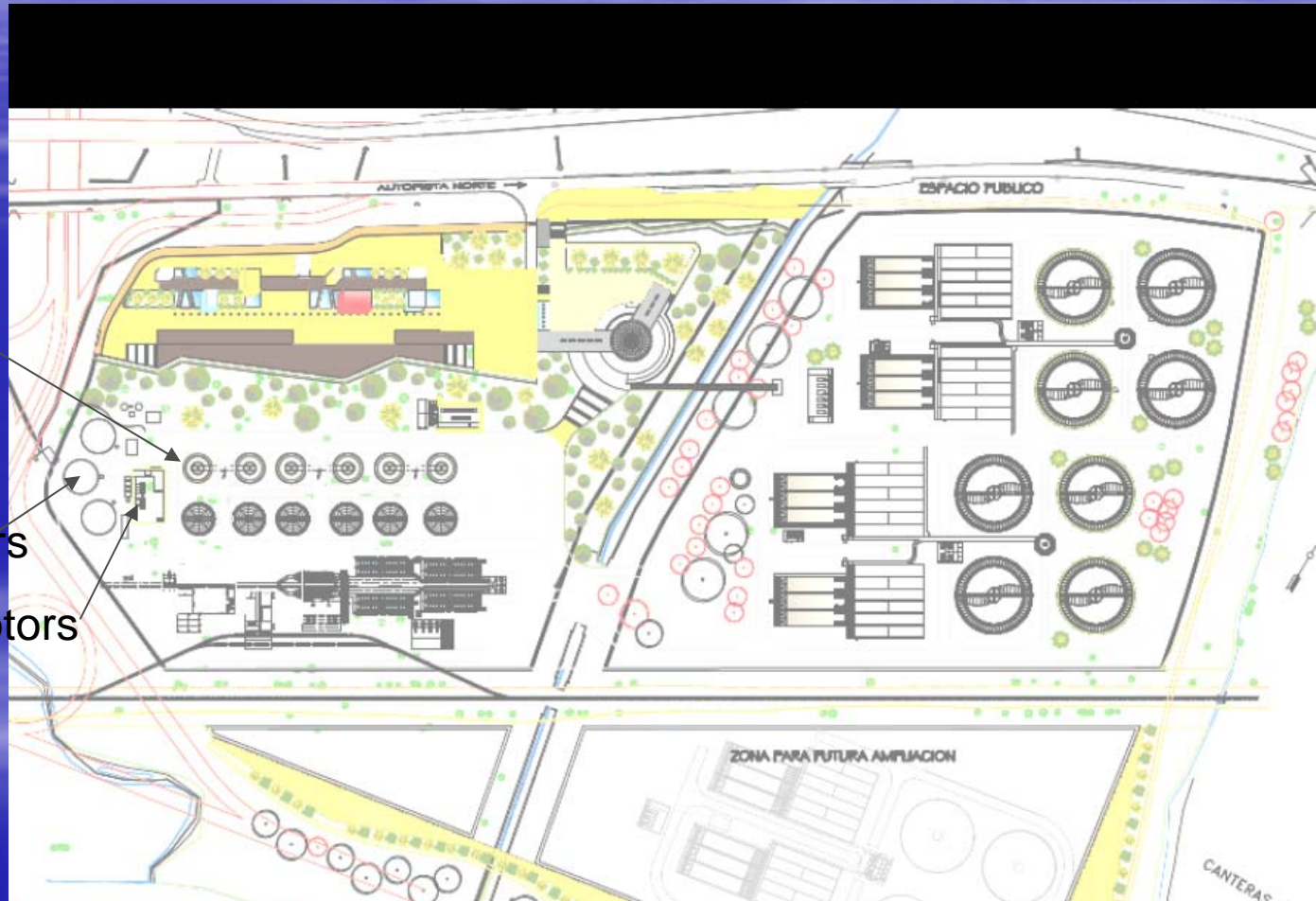

Huge experience in Chile



- La Farfana , 9 m³/s
- Santiago, Chile
- 30 – 40 MM³/year
- Energy for the plant
- Heat for digestors
- Gas to the city Metrogas Company



Metrogas - La Farfana project (US\$ 5 million)

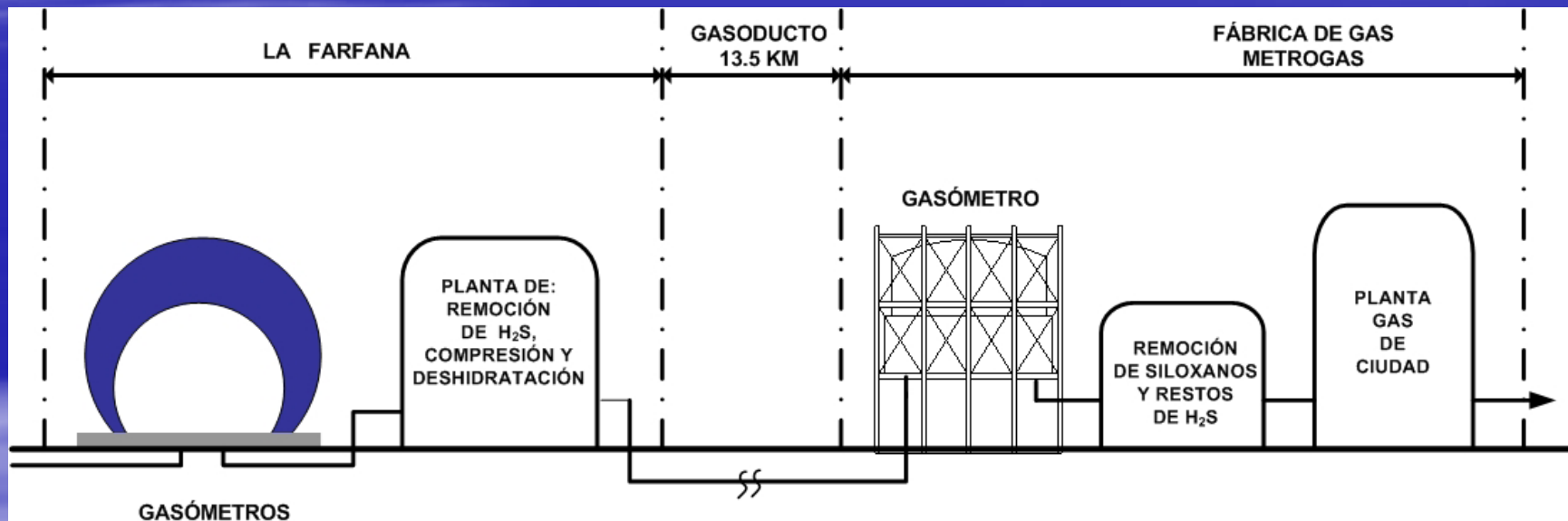

Energy recovery: from UASB reactors and from conventional WWTP digestors

- Arrudas WWTP, Belo Horizonte, Brasil – Activated Sludge with energy recovery from the digestors biogas.



Arrudas WWTP
Belo Horizonte, Brasil



Energy recovery at Arrudas WWTP

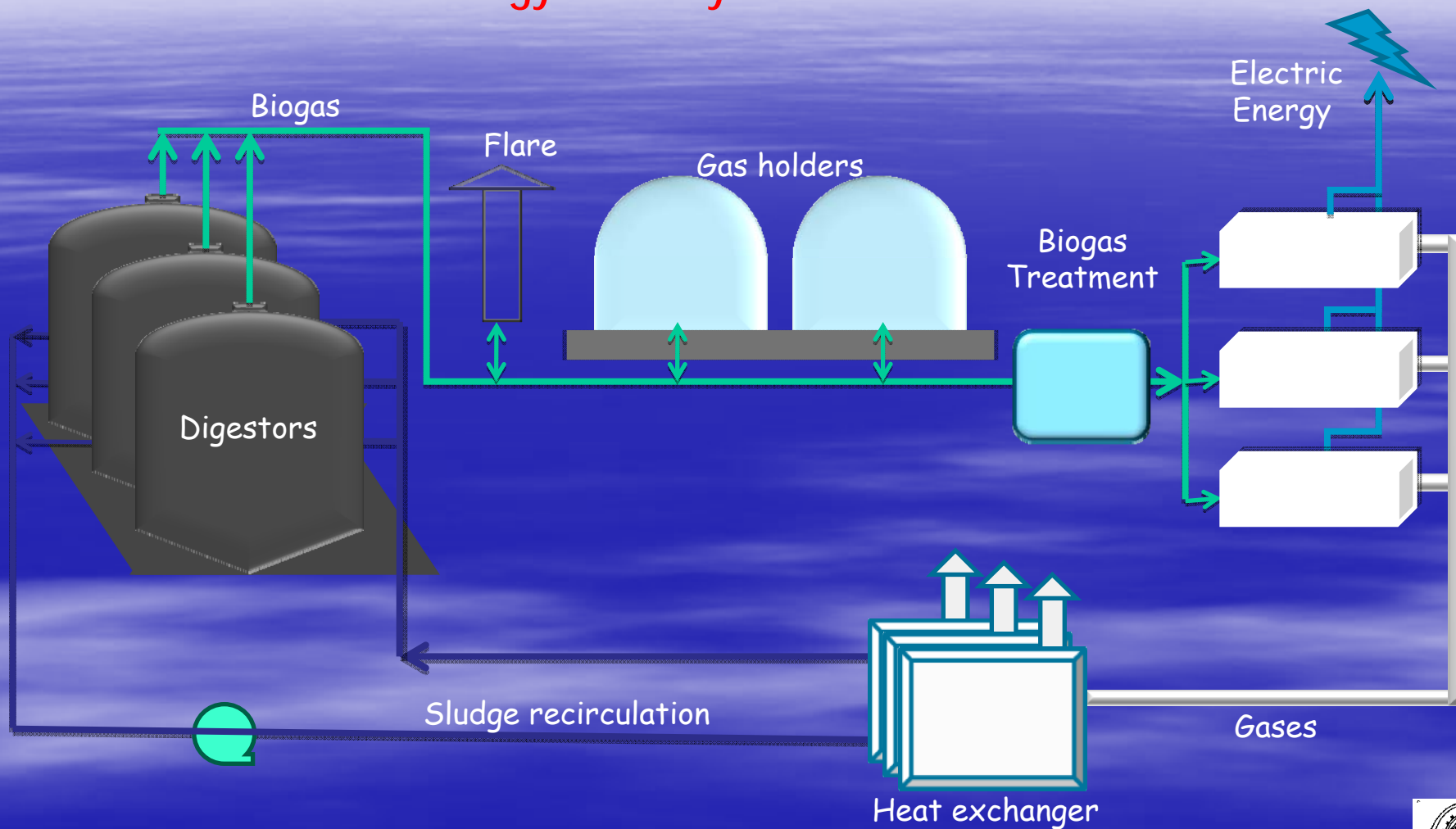

Energy recovery at Arrudas WWTP

- Gas purification
- Microturbines



Barueri WWTP
São Paulo, Brasil





Alegria WWTP
Rio de Janeiro

Think big: can we make sanitation sustainable?

- An evaluation of sanitation, health implications, costs, development, economy.
- Economical x new technologies
- Biofilm control technology ?
- Nanotechnology ?
- New membranes ?
- **Sludge and Biogas recovery ?**



MAKING SANITATION SUSTAINABLE

CAN WE MAKE IT ?

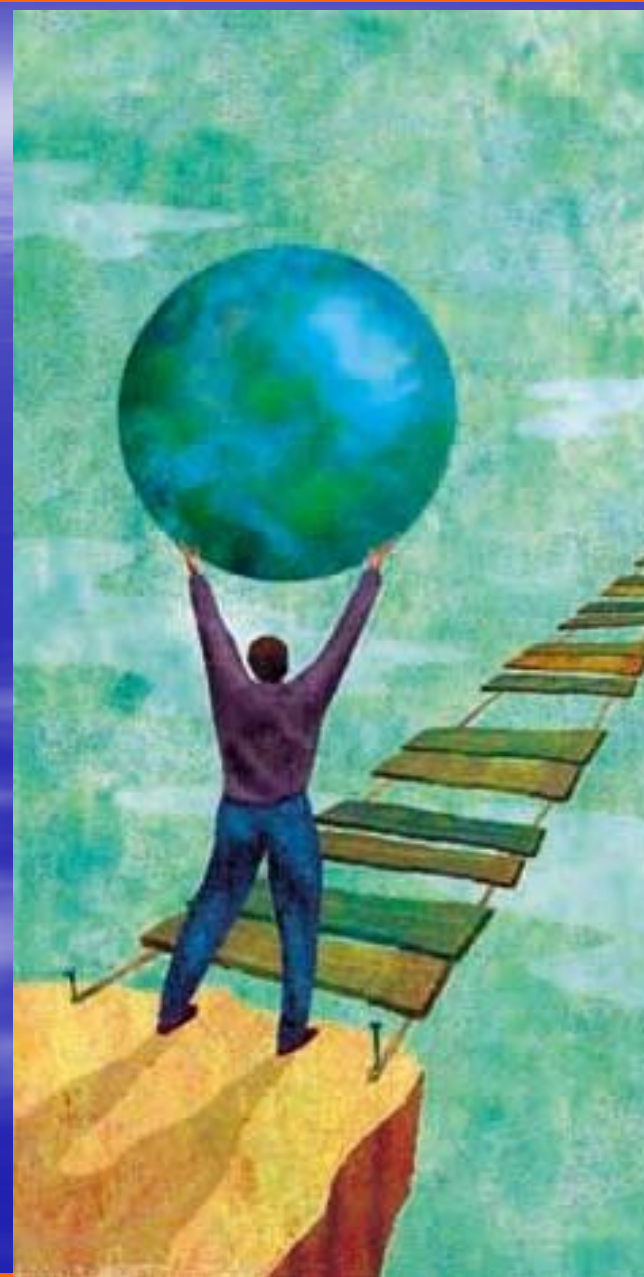

THANK YOU

Eduardo Pacheco Jordão, Dr.Eng.
jordao@poli.ufrj.br

