



Pre-Feasibility Study for Methane Drainage and Utilization at the TengHui Coal Mine, Shanxi Province, China

U.S. Environmental Protection Agency
March 2019

Publication No. 430R19005

**Pre-Feasibility Study for Methane Drainage and Utilization at the
TengHui Coal Mine
Shanxi Province
People's Republic of China**



U.S. Environmental Protection Agency, Washington, DC USA

March 2019

Publication No. 430R19005

Disclaimer

This publication was developed at the request of the United States Environmental Protection Agency (USEPA), in support of the Global Methane Initiative (GMI). Advanced Resources International, Inc. (ARI) under subcontract to RTI International, Inc., authored this report, based on information obtained from the coal mine partner, the TengHui Mine, Huozhou Coal Electricity, Shanxi Coking Coal Group Ltd., and REI Drilling Inc.

Acknowledgements

This report was prepared for the USEPA. This analysis uses publicly available information in combination with information obtained through direct contact with mine personnel, equipment vendors, and project developers. USEPA does not:

- a) make any warranty or representation, expressed or implied, with respect to the accuracy, completeness, or usefulness of the information contained in this report, or that the use of any apparatus, method, or process disclosed in this report may not infringe upon privately owned rights;
- b) assume any liability with respect to the use of, or damages resulting from the use of, any information, apparatus, method, or process disclosed in this report; nor
- c) imply endorsement of any technology supplier, product, or process mentioned in this report.

Figures

Figure ES-1: Contributions to total mine Methane Emissions over the period of evaluation.....	ES-2
Figure ES-2: Methane production forecast for the proposed methane drainage plan.	ES-3
Figure 1-1: Coal Production in China, 2007-2017	1
Figure 1-2: Percentage of Coal Consumption Accounting for total Energy Consumption in China, 2007-2017.	2
Figure 1-3: Depth of Coalbed Methane Resources in China.....	3
Figure 1-4: Location of TengHui Mine within the prefecture-level city of Linfen.....	5
Figure 2-1: Contributions to total mine Methane Emissions over the period of evaluation.....	8
Figure 2-2: Average annual specific emissions for the mine.	9
Figure 3-1: In-Seam drainage in advance of developments from alcoves developed every 50 m.....	10
Figure 3-2: Cross-panel in-seam boreholes spaced every 4 m in the No. 2 seam.....	11
Figure 3-3: Projected gas production and gas content reduction from a single cross-panel borehole in the No. 2 coal seam.....	12
Figure 3-4: In-seam mixed flow rate, methane flow rate, and methane concentration produced by the high vacuum system for the evaluation period.....	12
Figure 3-5: Plan view of typical high and low angle cross-measure boreholes.....	13
Figure 3-6: Profile view of high and low angle cross-measure boreholes.....	14
Figure 3-7: Gob gas flow rate, methane flow rate, and methane concentration produced by the low vacuum system for the evaluation period.....	15
Figure 3-8: Gas drainage schematic of the active mining area at the time of the mine visit.....	16
Figure 3-9: Plan view of LW 2-104 with longwall mining timing.....	18
Figure 3-10: Plan view of cross panel drilling scheme for LW 2-104.....	19
Figure 3-11: Front view of cross panel drilling scheme for LW 2-104.....	19
Figure 3-12: Methane production from in-seam cross panel boreholes for LW 2-104.....	20
Figure 3-13: Methane concentration from the in-seam cross panel boreholes for LW 2-104.....	20
Figure 3-14: Profile view of cross-measure boreholes for LW 2-104.....	21
Figure 3-15: Methane production from the cross-measure system during mining of LW 2-104.....	22
Figure 3-16: Methane concentration of the gob gas produced during mining of LW 2-104.....	22
Figure 3-17: Methane gas liberated into the ventilation system for LW 2-104.....	23
Figure 3-18: Total methane liberated during mining of LW 2-104.....	24
Figure 3-19: Longwall methane drainage efficiency for LW 2-104.....	24
Figure 3-20: Emissions from LW 2-104 compared to total mine emissions.....	25
Figure 3-21: Schematic used to derive the underground balance of methane emissions.....	26
Figure 3-22: The contribution to the total mine Methane Emissions from each working area.....	27
Figure 4-1: Profile view of in-seam drainage concept for the No. 10 seam.....	31
Figure 4-2: Future mining projections in the No. 2 seam.....	32
Figure 4-3: Future mining projections in the No. 10 seam.....	33
Figure 4-4: Plan view of the No. 2 seam correlation model.....	34
Figure 4-5: Profile view of the No. 2 seam correlation model.....	34
Figure 4-6: Match of the theoretical gas production rate from 1 x 165 m cross-panel borehole spaced 4 m apart.....	35
Figure 4-7: Plan view of long hole spacing models.....	36
Figure 4-8: Front view of long hole spacing models.....	36

Figure 4-9: Results of gas content reduction versus borehole spacing analysis in the No. 2 seam.	37
Figure 4-10: Results of gas content reduction vs. borehole spacing analysis in the No. 10 seam.	38
Figure 4-11: Plan view of in-seam methane drainage approach in the No. 2 seam.....	39
Figure 4-12: Plan view of in-seam methane drainage approach in the No. 10 seam.....	40
Figure 4-13: Profile view of the HGB drilling approach.	41
Figure 4-14: Gas flow rate (70 percent methane in air) for 1,000 m HGB configurations with wellhead vacuum of 20 kPa.....	43
Figure 4-15: Gas flow rate (70 percent methane in air) for a 1,000 m x 96 mm diameter HGB as a function of wellhead vacuum.....	43
Figure 4-16: Plan view of gob degasification plan in the No. 2 seam.	44
Figure 5-1: Methane production forecast for the proposed methane drainage plan.....	46
Figure 7-1: Proposed plan costs compared to existing plan costs (both discounted).	60
Figure 7-2: Depiction of discounted cost savings over time; cumulative and annual.	61
Figure 7-3: Emission reductions occur at a steady rate after gas delivery and use occurs.	62
Figure 7-4: Annual generation output of 19,479 MWh occurs for entire project from 2021-2029.....	62

Tables

Table ES-1: Breakdown of project returns for the power plant and gas drainage programs separated, and in conjunction.	ES-4
Table ES-2: Summary of Economic Results for power plant (only) (pre-tax).....	ES-5
Table ES-3: Summary of Economic Results for power plant and gas drainage programs (pre-tax).	ES-5
Table ES-4: Cost savings attributable to improved gas drainage using directional drilling.	ES-6
Table 3-1: Balance of methane emissions underground at the mine on May 10, 2016.....	26
Table 4-1: Longwall panel dimensions for future mining in the No. 2 seam.	32
Table 4-2: Critical reservoir parameters derived for the No. 2 seam.	35
Table 4-3: Drainage time and avg. gas production rates vs. borehole spacing in the No. 2 seam.	37
Table 4-4: Drainage time and avg. gas production rates vs. borehole spacing in the No. 10 seam.	38
Table 4-5: Pre-mining directional drilling schedule for the No. 2 seam.	39
Table 4-6: In-seam directional drilling plan for the proposed No. 10 seam workings.....	41
Table 5-1: Gas production rates derived from the methane drainage plan developed for the Project Period.	45
Table 5-2: Projected annual drilling and requirements for the proposed drilling plan.	46
Table 5-3: Projected annual pipeline requirements should the mine proceed with current methane drainage practices through the Project Period.	47
Table 7-1: Summary of Drainage System Input Parameters.....	55
Table 7-2: Summary of Power Plant Input Parameters.	56
Table 7-3: High, base and low case sensitivities used for key inputs of the financial analysis.....	58
Table 7-4: Power Plant (only) IRR scenarios (pre-tax).	59
Table 7-5: Summary of Economic Results for power plant and gas drainage programs (pre-tax).....	59
Table 7-6: Cost savings attributable to improved gas drainage using directional drilling.....	60

Table of Contents

Disclaimer.....	i
Acknowledgements.....	i
Figures.....	ii
Tables.....	iv
Acronyms/Abbreviations	viii
Executive Summary.....	1
1 China’s Coal Industry and Coal Mine Methane.....	1
1.1 China’s Coal Industry.....	1
1.2 Coal Mine Methane in China	2
1.3 Selection of the TengHui Coal Mine for the Pre-Feasibility Study	3
1.4 TengHui Coal Mine	4
1.4.1 Location of the TengHui Mine	5
1.4.2 Topography and Climate	6
1.4.3 Regional Geology.....	6
1.5 Shanxi Coking Coal Group – Owner/Operator of the TengHui Mine	7
2 Mine Methane Emissions.....	8
2.1 Distribution of Mine Methane Emissions	8
2.2 Specific Methane Emissions.....	8
3 Methane Drainage and Use at the Tenghui Mine.....	10
3.1 Current Practices.....	10
3.1.1 Pre-Mining Drainage	10
3.1.2 Gob Gas Drainage	13
3.1.3 Methane Use.....	15
3.2 Underground Visit of the Tenghui Mine	15
3.2.1 Pre-Mining Drainage	16
3.2.2 Gob Gas Drainage	16
3.2.3 Methane Emissions into the Ventilation System	17
3.2.4 Vacuum Station.....	17
3.2.5 Observations from the Site Visit	17
3.3 Analysis of Underground Methane Emissions	17
3.3.1 Longwall Panel 2-104.....	18
3.3.2 Methane Drainage of LW 2-104.....	18

3.3.3	Ventilation of LW 2-104	22
3.3.4	Total Methane Emissions from LW 2-104.....	23
3.3.5	Relative Methane Emissions from LW 2-104	24
3.3.6	The Balance of the Methane Emissions	25
3.4	Observations and Recommendations	28
3.4.1	Mine Methane Emissions.....	28
3.4.2	Source of Methane Emissions.....	28
3.4.3	Gas Content Reduction	28
3.4.4	Gob Degasification	29
3.4.5	Underground Gas Management	29
4	Recommended Improvements to Methane Drainage and Use Practices	30
4.1	Recommended In-Seam Methane Drainage Approach	30
4.1.1	Direct Drilling Approach.....	30
4.1.2	Future Mining Plans	31
4.1.3	Reservoir Modeling to Correlate with Existing In-Seam Borehole Production.....	33
4.1.4	Reservoir Modeling to Derive Borehole Spacing as a Function of Drainage Time	35
4.1.5	Pre-Mining Methane Drainage Plans for the No. 2 and No. 10 Seam Workings	38
4.2	Recommended Gob Gas Drainage Approach	41
4.2.1	Gob Gas Drainage Plan for the No. 2 Seam Mine Workings	41
4.2.2	Gob Gas Drainage Plans for the No. 10 Seam Workings.....	44
5	Future Methane Drainage Projections.....	45
5.1	Borehole Production Rates	45
5.2	Mine Methane Drainage Production Rates	45
5.3	Methane Drainage Drilling Requirements	46
6	Market Information	48
6.1	Shanxi Province Economic Conditions	48
6.2	Energy Commodity Markets in Shanxi Province	49
6.2.1	Power	49
6.2.2	Other Relevant Energy Markets.....	49
6.3	Environmental Markets	50
6.4	Legal and Regulatory Environment.....	51
6.5	CMM Utilization Options for the TengHui Mine	51
6.5.1	Power Generation.....	51

6.5.2	Town Gas/Natural Gas	51
6.5.3	Industrial Use	52
6.5.4	Boiler Fuel	52
6.5.5	Compressed Natural Gas (CNG)/Liquefied Natural Gas (LNG).....	52
6.5.6	Flaring.....	52
6.6	Recommendation for CMM Utilization.....	53
7	Economic Analysis.....	54
7.1	Project Development Overview	54
7.2	Project Economics.....	54
7.2.1	Economic Assessment Methodology	54
7.2.2	Economic Assumptions	54
7.2.3	Economic Results	58
7.2.4	Greenhouse Gas Emission Reductions and Energy Generation.....	61
8	Conclusions, Recommendations and Next Steps.....	63
9	References	65

Acronyms/Abbreviations

AMM	Abandoned Mine Methane
ARI	Advanced Resources International, Inc.
Bcm	Billion cubic meters
CCII	China Coal Information Institute
CDM	Clean Development Mechanism
CERs	Certified Emission Reductions
CH ₄	Methane
CMOP	US EPA Coalbed Methane Outreach Program
CMM	Coal Mine Methane
CNG	Compressed natural gas
CO ₂	Carbon Dioxide
CORSIA	Carbon Offsetting and Reduction Scheme for International Aviation
D	Day
ETS	Emissions trading system
GMI	Global Methane Initiative
Gt	Billion tonnes
HGB	Horizontal (directionally drilled) gob borehole
ICAO	International Civil Aviation Organization
IRR	Internal rate of return
kPa	Kilopascal
LNG	Liquefied natural gas
LW 2-104	Long Wall Panel 2-104
m	Meters
m ³	Cubic meters
min	Minutes
mm	Millimeters
MT	Million Tonnes
MtCO ₂ e	Metric tonnes of CO ₂ equivalent
MW	Megawatt
NDRC	National Development and Reform
No.	Number
NPV	Net present value
ROM	run of mine
SASAC	State-owned Assets Supervision and Administration Commission
SCCG	Shanxi Coking Coal Group, Ltd.
T	Tonne
Tcm	Trillion cubic meters
UNFCCC	United Nations Framework Convention on Climate Change
USEPA	United States Environmental Protection Agency

Executive Summary

The U.S. Environmental Protection Agency's (USEPA) Coalbed Methane Outreach Program (CMOP) works with coal mines in the U.S. to encourage the economic use of coal mine methane (CMM) gas that is otherwise vented to the atmosphere. Methane is both the primary constituent of natural gas and a potent greenhouse gas (GHG) when released to the atmosphere. Reducing emissions can yield substantial economic and environmental benefits, and the implementation of available, cost-effective methane emission reduction opportunities in the coal industry can lead to improved mine safety, greater mine productivity, and increased revenues.

The work of USEPA also directly supports the goals and objectives of the Global Methane Initiative (GMI), an international partnership of 44-member countries and the European Commission that focuses on cost-effective, near-term methane recovery and use as a clean energy source. These studies identify cost-effective project development opportunities through a high-level review of gas availability, end-use options, and emission reduction potential. This study assists mine operators in evaluating options for CMM capture and use while also presenting a preliminary financial analysis and laying the foundation for a more detailed feasibility study that will ultimately lead to CMM project development and GHG emission reductions.

This pre-feasibility study was completed as part of an integrated Best Practices training program for the China International Centre of Excellence on Coal Mine Methane (ICE-CMM) conducted from June through October 2018 with preparatory work, including initial data requests, beginning in January 2018. The China ICE is a non-profit entity with the objective of becoming a self-sustaining organization able to identify and evaluate opportunities for CMM recovery and use along with the capacity to transfer good practices on methane capture and utilization in coal mines. An integral part of the training was instruction on and completion of a detailed pre-feasibility study, using preparation and completion of the TengHui study as a real-world training platform. The TengHui Mine was selected for this pre-feasibility study in consultation with the China ICE and with the support of Huozhou Coal Electricity Group, the mine's parent company, and Huozhou's parent holding company, Shanxi Coking Coal Group Co. Ltd. (SCCG). The TengHui Mine was chosen because it is classified as a coal and gas outburst mine with permitted coal production over 1 million tonnes per annum. The mine currently produces 1.2 MMT per year. Although it employs a gas drainage system, the mine does not utilize any of the CMM produced in the mine. Furthermore, in discussions with GMI, officials from the ICE, the TengHui Mine, Huozhou, and SCCG all demonstrated a strong commitment to implement a CMM project if the project appears to be technically and economically feasible.

The TengHui Mine is located in China's Shanxi Province, situated along the western border of the province in the western part of Diangou village, Zaoling Town, Xiangning County. There are two mineable seams for coal production at the TengHui Mine, the No. 2 seam and the No. 10 seam. The No. 2 seam is the only seam that is currently being mined. Approximately 50 percent of the methane produced from mining activity is liberated. Methane emissions from mine developments, in-seam boreholes drilled in advance of developments, gas from sealed gobs/areas, standing ribs and faces, and coal production conveyors account for a significant portion of the emissions from the mine.

Approximately half of the total mine methane emissions are vented to the atmosphere via the mine's ventilation system. The majority of the balance of the methane gas is captured by a network of in-seam

boreholes developed for the purposes of pre-mine drainage. A small amount of methane gas is captured from cross-measure boreholes and large diameter through-pillar boreholes intended to capture gob gas.

Average total mine methane emissions are 53,280 m³/d. The approximate specific emissions from the mine are 15.5 m³/t. The average in-situ gas content of the mining seam, the No. 2, is reported as 9.2 m³/t, and the underlying seam, the No. 10, is reported as 7.7 m³/t. The No. 2 seam is, 4.9 – 7.5 m thick, and likely requires gas content reduction through pre-mining drainage to achieve reasonable mine production rates when mined in a single lift, e.g. longwall shearer plus top-caving, as practiced.

The No. 2 coal seam is the source of the majority of methane emissions from the mine. 46 percent of total mine methane emissions are from boreholes drilled in the No. 2 seam, 20 percent of total mine methane emissions are from the longwall face during mining of the No. 2 seam, and 20 percent of total mine methane emissions are from ventilating workings in the No. 2 seam (besides the active longwall). The recovered gob gas makes up less than 5 percent of total mine methane emissions and is likely from remnant coal left from top caving rather than overlying gas bearing strata, which is limited. Figure ES-1 illustrates the contribution of the three (3) methane flow streams to total mine methane emissions through the period of evaluation.

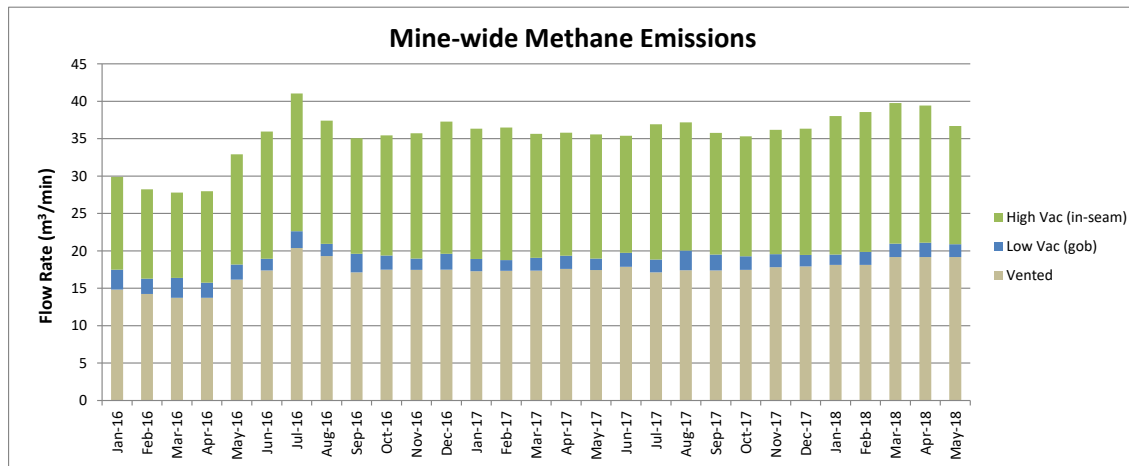

Figure ES-1: Contributions to total mine methane emissions over the period of evaluation.

A significant amount of historical information relating to methane drainage system performance and methane concentrations in the ventilation air courses of the mine was provided for analysis. This information provided the ability to assess the distribution of methane emissions underground and contribution of various activities such as mining of longwall panels versus developments. Data was provided for specific days in each month from January 2016 through the end of May 2018. Daily data for each month was averaged and represented as average monthly data.

One of the most significant concerns with the existing CMM production program at TengHui is the low methane concentration in the gas drainage system. This prohibits utilization of the gas and is also a direct threat to safety and health. A study area, Longwall Panel 2-104 (LW 2-104) in the year 2016, was chosen to analyze historic methane drainage rates, methane concentrations and airflows. For in-seam boreholes, reservoir modeling was performed to aid in deriving the in-seam methane drainage plan for the mine. An initial reservoir model was developed to correlate predictions of gas flow and gas content reduction as a function of time with theoretically predicted methane production from the in-seam boreholes

implemented at the mine. With respect to gob gas, the drilling pattern in Longwall Panel 2-104, two cross-measure gob wells are drilled every four meters for the equivalent of 500 boreholes in a 1200m longwall panel. Similar to in-seam boreholes, historic gob gas flow rates, methane concentrations, and methane production were analyzed. Methane emissions from gob wells are forecasted with an engineering equation that calculates gob gas flow rates using the gob gas flow rate of the horizontal gob boreholes (HGB) as a function of gas composition and borehole diameter .

To improve in-seam methane drainage effectiveness, the pre-feasibility study report recommends that the mine replace the short in-seam cross-panel boreholes with long directionally drilled boreholes placed in advance of and flanking mine developments. This would reduce the number of wellheads and potential points of air leakage into the gas drainage system. To improve gob degasification, HGB's drilled from the mining seam to a derived height above the low-pressure side of the longwall panel near the tailgate entry are recommended. The recommended practices will in effect improve recovered gas quality, reduce methane drainage costs, and increase the value of the gas.

The initial analysis of LW 2-104 provided projected gas production rates for a single longwall panel; annual methane gas production forecasts were developed for the project period, spanning ten years from 2019 to 2029. To create a mine methane drainage plan, future production forecasts were generated for the period between 2019 and 2029 based on current mine information and extrapolation assuming consistent coal production rates and mining techniques. Assuming the recommended methane drainage improvements are in place, the forecast predicts recovery of an average of 8 million cubic meters of methane between 2019 and 2023 from the No. 2 seam. After 2024, when mining moves to the No. 10 seam, an average of 3 million cubic meters of methane per year is predicted. Figure ES-2 summarizes the methane production forecast for the proposed methane drainage plan.

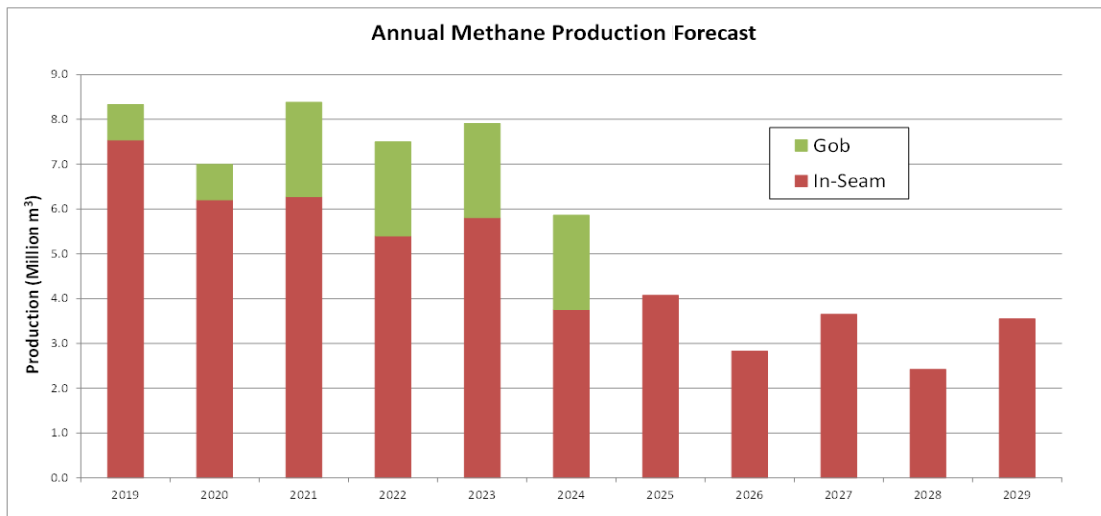

Figure ES-2: Methane production forecast for the proposed methane drainage plan.

Although multiple options exist for CMM use at TengHui Mine, power production is the most viable option based on preliminary findings from the study. Chinese coal mining companies, including SCCG, have significant experience implementing CMM power generation projects throughout China and, more specifically, within Shanxi Province. In addition, the industrial power sales price of RMB 0.65/kWh

(\$0.094/kWh) paid by the TengHui Mine and the subsidy of RMB 0.40/m³ (\$59,717/Mm³) of pure methane used makes power production very attractive as an end-use option.

The financial analysis considers the entire capital and operating costs of the project including the cost of drilling boreholes, the gathering system, and the power plant. To better understand the costs and benefits of the project and the financial analysis, the study presents the returns of the entire project inclusive of drilling costs and the returns of the surface CMM power plant alone. The financial analysis also examines the costs and cost savings of modifying the gas drainage approach as proposed in this study. Table ES-1 illustrates the components and different scenarios of the report that were evaluated using the financial analysis.

Project Scenario	Description
Power Plant and Gas Drainage Program	<ul style="list-style-type: none"> • This program encompasses the return scenarios from the proposed gas drainage and power plant plans while operating in tandem. • Costs associated with gas drainage involve in-seam drilling, HGBs and vertical well interceptions. The power plant's power price, generator efficiency and subsidies all substantially impact project net present value (NPV) and internal rate of return (IRR). • Gas from the drainage program feeds into power plant at no cost in this specific program.
Power Plant Program Only	<ul style="list-style-type: none"> • Per TengHui Mine Management's request, this program represents a scenario where the gas drainage program's costs are absorbed as operational costs by the mine. • Cash flows from gas drainage are effectively null to highlight returns of the power plant as a standalone.
Gas Drainage Program Only	<ul style="list-style-type: none"> • This program highlights the return scenarios of current/existing gas drainage program and a proposed gas drainage program. • The cost savings NPV serves as a comparison tool when evaluating whether to use the proposed gas drainage program or the current program. • The current gas drainage program contains two subparts to provide a detailed analysis for potential drilling scenarios that mine operators may consider: 1.) Cross-measure boreholes are not drilled in the No. 10 seam and, 2.) Cross-measure boreholes are drilled in the No. 10 seam.

Table ES-1: Breakdown of project returns for the power plant and gas drainage programs separated, and in conjunction.

The results from the financial analysis of the power plant, separate from the gas drainage program, are presented in Table ES-2. The high case represents the most optimistic scenario in terms of returns. The base case is the most realistic return scenario given available data used for key inputs in the financial

analysis. The low case is a sub-optimal scenario where production levels are low, and costs run higher than expected among other more pessimistic project assumptions. It should be noted that the IRR's and NPV's presented in Table ES-2: Summary of Economic Results (pre-tax) for power plant (only). are pre-tax, thus it would be expected that post-tax returns will result in some reduction in the IRR's. In addition, the analysis does not consider a purchase price for the gas incurred by the CMM plant. It is assumed that the CMM is provided free of charge by the mining operation. Should the mining operation wish to internalize the price of gas as a revenue and charge a fee, then the power project would need to show a cost of gas purchased as an operating cost, which would likely reduce the IRR's.

Case	Max Power Plant Capacity	NPV (\$,000s)	IRR	Payback (Years)	Net CO ₂ e Reductions (t CO ₂ e)
High	5.23 MW	\$11,045	43.57%	2.3	1,481,616
Base	3.71 MW	\$2,966	19.97%	4.5	1,139,704
Low	3.47 MW	\$69	10.30%	6.3	797,793

Table ES-2: Summary of Economic Results (pre-tax) for power plant (only).

Returns for the entire project which includes both the gas drainage program and the surface utilization project are presented in Table ES-3: Summary of Economic Results for power plant and gas drainage programs (pre-tax). Returns are less favorable for the entire project compared to the power plant only, as high case IRR is 22.06 percent and 43.57 percent, respectively. Costs of the drainage program are not absorbed by the mine in this case, which is why returns are significantly lower in Table 7-5. Similar to Table ES-2: Summary of Economic Results (pre-tax) for power plant (only)., the results in Table ES-3 are pre-tax and do not consider a purchase price for the gas incurred by the CMM plant. There is an expected reduction in IRR post-tax, and if a gas purchase price for the proposed CMM plant were to be implemented.

Case	Max Power Plant Capacity	NPV (\$,000s)	IRR	Payback (Years)	Net CO ₂ e Reductions (t CO ₂ e)
High	5.23 MW	\$9,491	22.06%	4.9	1,481,616
Base	3.71 MW	\$1,684	12.23%	6.45	1,139,704
Low	3.47 MW	\$(943)	8.72%	7.24	797,793

Table ES-3: Summary of Economic Results for power plant and gas drainage programs (pre-tax).

The analysis also considers only the cost of changing drainage practices from cross-panel and cross-measure boreholes to directionally drilled boreholes absent a utilization project at the surface (see Table ES-4). If the TengHui Mine were to maintain its current business-as-usual approach using in-seam and cross-measure boreholes in the No. 2 and No. 10 seams, the cost savings realized from switching to directionally drilled boreholes would be \$11 million. Even if the mine were to eliminate to cross-measure boreholes in the No. 10 seam in the business-as-usual approach, it would still see cost savings of \$5.4 million from changing to directional boreholes.

Existing Case	Proposed Plan's NPV of Cost Savings (\$,000s)
Cross-measure boreholes not drilled in the No. 10 seam	5,442
Cross-measure boreholes drilled in the No. 10 seam	10,943

Table ES-4: Cost savings attributable to improved gas drainage using directional drilling.

The proposed gas drainage approach offers cost savings compared to existing drilling programs for the following reasons:

- Fewer boreholes are drilled and there is a significant reduction in total borehole length in the proposed plan.
- The existing approach uses almost 7 times more pipeline than the proposed plan.
- Only in-seam boreholes are drilled in the No. 10 seam. HGB's are not necessary.

The proposed CMM project has optimal net emission reductions potential of 1,481,616 tCO₂e alongside 5.23 MW of power production capacity, which highlights an attractive financial opportunity with benefits of emission reductions and increased energy security. As a pre-feasibility study, this report is intended to provide an initial assessment of project feasibility. Further site-specific analysis may be necessary to develop a “bankable” feasibility study acceptable to project investors, banks, and other sources of finance. Sections 7 and 8 provide further guidance and recommendations to aid in the assessment of a CMM capture and use project.

1 China's Coal Industry and Coal Mine Methane

1.1 China's Coal Industry

In 2017, China ranked first in global coal production with 3,523 million tonnes (Mt) of production, accounting for 46 percent of the global share (BP, 2018). Between 2007 and 2017, China's coal production increased by 308 Mt, or 21 percent (Figure 1-1). In 2014, coal production began stabilizing due to decreased demand (BP, 2018).

At the end of 2017, China's total proved reserves of coal were 138,819 Mt (ranked fourth globally behind the U.S., Russia, and Australia), with 94 percent being anthracite or bituminous coal, and the remaining 6 percent being sub-bituminous or lignite (BP, 2018). China's coal reserves are located throughout the country with the majority located in Shanxi, Inner Mongolia, Xinjiang, Shaanxi, and Guizhou provinces, with Shanxi ranking first in total reserves (US EIA, 2015).

As shown in Figure 1-1, coal production has grown from 2.76 billion tons (Gt) in 2007 to 3.53 Gt in 2017, although coal production in 2017 is down from peak production of 3.97 Gt in 2013. Total coal consumption in China was 3.81 Gt in 2015. By the end of 2017, total annual coal consumption in China accounted for 60 percent of total energy consumption (Figure 1-2), but the Chinese Government is targeting a consumption level of 58 percent by 2020 in the energy development strategy plan released by the State Council (NRDC, 2016).

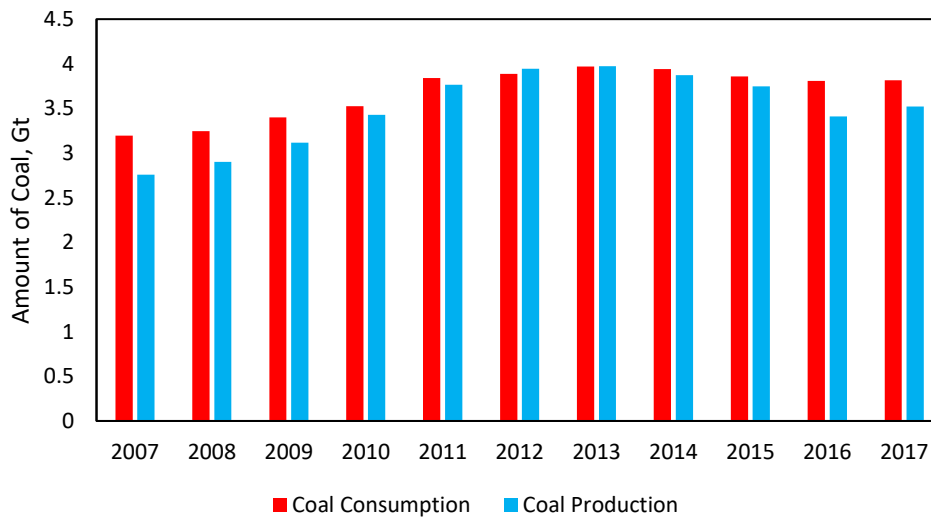

Figure 1-1: Coal Production in China, 2007-2017

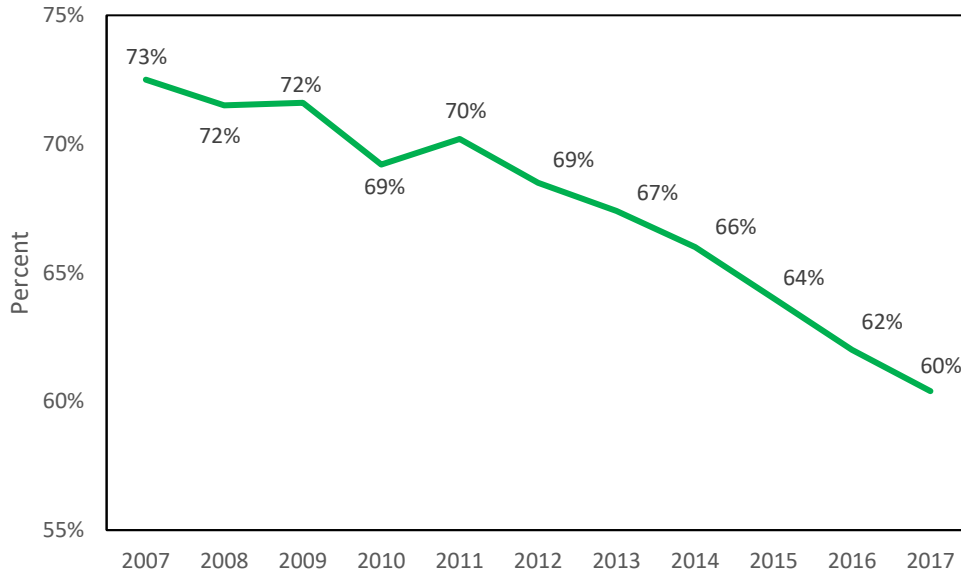

Figure 1-2: Percentage of Coal Consumption Accounting for total Energy Consumption in China, 2007-2017.

The Chinese government is currently attempting to consolidate the nation’s coal mines to improve industry economics, reduce pollution, make the national coal industry more efficient, and improve safety (USEPA, 2015). As of 2017, 7,000 coal mines exist in China compared to 24,800 mines in 2005 (Huang, 2018). There are plans to close down an additional 4,000 small coal mines and 300 large mines with coal reserves that will become depleted in the next three to five years.

1.2 Coal Mine Methane in China

China’s CMM emissions were reported to be 17.8 billion cubic meters (Bcm) in 2017 (Huang, 2018). Coal producers continue to face significant challenges related to CMM management and mine safety. In 2017, 12.8 billion cubic meters (Bcm) of CMM were drained in China, of which 4.9 Bcm were utilized (Huang, 2018). While CMM emission production has plateaued in the past three years, recovery of CMM has steadily increased over the past as efforts to capture methane have increased. Nevertheless, the Chinese government continues to provide financial support for CMM recovery as an attempt to increase CBM/CMM utilization to 20 Bcm by 2022.

The *China Petroleum Resource Assessment* indicates that the total coalbed methane (CBM) resource in China is about 36.81 trillion cubic meters (Tcm). The burial depth of most CBM resources is less than 2,000 m with 39 percent of the total resource between depths of 1000 m to 1500 m (Figure 1-3).

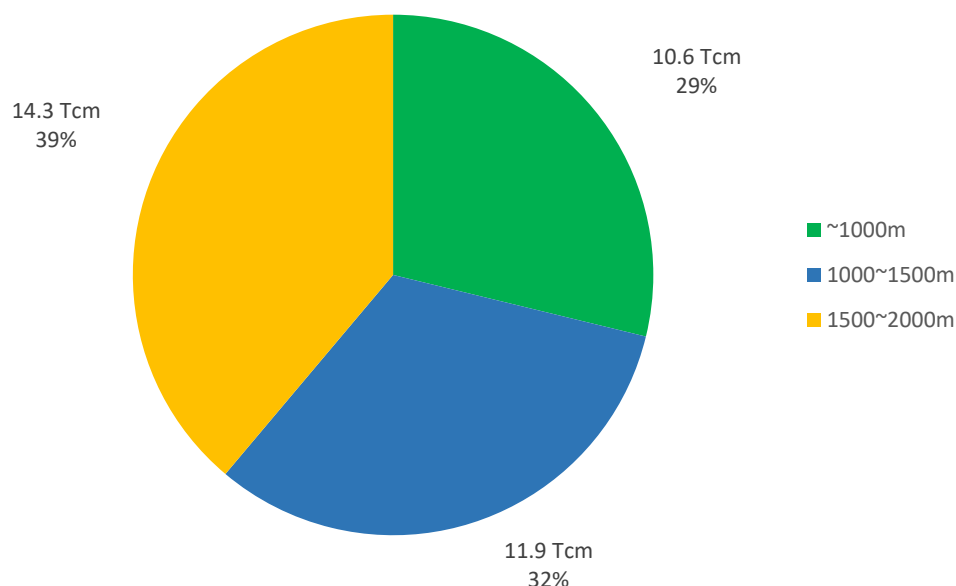

Figure 1-3: Depth of Coalbed Methane Resources in China.

Despite the slight reduction in total coal production from its peak, the volume of drained and utilized CMM is expected to continue increasing as shallower coal reserves become exhausted and mines begin to develop deeper, gassier coal seams to meet demand. CMM drained and utilized is also expected to increase as mines develop more experience with gas capture and use, as gas drainage methods improve, and as coal production becomes concentrated in large-scale gassy mines. Capture and use of CMM is also a provincial and national priority in coal mining provinces, including in Shanxi province where the TengHui Mine is located.

1.3 Selection of the TengHui Coal Mine for the Pre-Feasibility Study

This pre-feasibility study was completed as part of an integrated Best Practices training program for the China International Centre of Excellence (ICE) on CMM emissions conducted from June through October 2018 with preparatory work, including initial data requests, beginning in January 2018. The China ICE-CMM is a non-profit entity subject to the national laws of China operating under the sponsorship of the United Nations Economic Commission for Europe (UNECE) Group of Experts on CMM emissions. The objective of the ICE training was to support the China ICE-CMM in becoming a self-sustaining organization with the capability to identify and evaluate opportunities for CMM recovery and use and the capacity to transfer good practices on methane capture and utilization in coal mines. The China ICE-CMM aims to provide a platform for discussion on safety, environmental and economic aspects of CMM, focusing on issues such as effective drainage and the abatement of methane emissions from coal mines. Activities conducted by the China CMM-ICE include exchanging knowledge and experiences in reducing methane emissions from coal mines, organizing professional trainings, and contributing to further development of effective methane drainage techniques in mines. An integral part of the training was instruction on and completion of a detailed pre-feasibility study, using preparation and completion of the TengHui study as a real-world training platform.

The TengHui Mine was selected for this pre-feasibility study in consultation with the China ICE and with the support of Huozhou Coal Electricity Group, its parent company, and Huozhou's parent holding company, Shanxi Coking Coal Group Co. Ltd. (SCCG). to determine the technical and economic viability of a CMM capture and utilization project.

The TengHui Mine is an excellent subject for a pre-feasibility for the following reasons:

- The mine is classified as a coal and gas outburst mine.
- The mine maintains a gas drainage system using both in-seam and cross-measure boreholes but currently does not utilize any of the CMM produced from the gas drainage system.
- Methane concentrations in the drainage system are within and below the explosive range; therefore, a pre-feasibility study could present recommendations for improvements to gas drainage increasing the gas quality and quantities available for use.
- The mine has a demand for electricity, thus there is a market for power produced from CMM.
- TengHui Mine's parent company, Huozhou Coal Electricity Group Co., has experience with CMM recovery and use as does Huozhou's parent, Shanxi Coking Coal Group, Ltd (SCCG).
- Favorable electricity prices and CMM subsidies in Shanxi province provide economic incentives for CMM projects.
- In discussions with GMI, TengHui, Huozhou, and SCCG officials demonstrated a strong commitment to proceed with a CMM project if the project appears to be technically and economically feasible (recognizing that the pre-feasibility study is only an initial assessment of project feasibility).

1.4 TengHui Coal Mine

The TengHui Coal mine is in Shanxi province in the southeastern part of the Ordos Basin in Northern China. The mine is classified as a coal and gas outburst mine and is currently permitted to produce 1,200,000 tonnes per annum. The TengHui Mine has two mineable seams: The Shanxi Group No. 2 seam and the Taiyuan Group No. 10 seam. The mine holds estimated coal reserves of 25.1 million tons— the No. 2 seam has 10.5 million tons of recoverable reserves and the No. 10 seam has 14.6 million tons. Presently, only the No. 2 seam is being mined, producing 5.0 million tonnes of coal between 2012 and 2018. The mine is estimated to have a mineable lifespan of 14.9 years (6.2 years at the No. 2 seam and 8.7 years at the No. 10 seam).

The No. 2 seam is located in the upper part of the lower section of the Shanxi group, 17.29m above the K7 sandstone and 43.11~52.18m above No. 10 seam, with an average distance of 47.3m. The thickness of the seam is 4.88~7.47m, with an average thickness of 5.94m. The No. 2 seam has a simple structure that includes 0-2 layers of gangue and has a stable, mineable seam throughout the mine. Situated between a sandy mudstone on top and mudstone on the bottom, the coal from this seam is primarily composed of meager-lean coal, with some meager and lean coal.

The No. 10 seam is located in the upper part of the lower section of Taiyuan group, under K2 limestone, 14.58m above K1 sandstone. The thickness of the seam is 1.92~4.85m, with an average thickness of 3.60m. The No. 10 seam is considerably thinner than the No. 2 seam. The No. 10 seam also has a simple structure that includes 0-2 layers of gangue and has a stable, mineable seam throughout the mine.

Situated between a limestone and mudstone from the top and mudstone on bottom, the No. 10 coal seam is primarily composed of meager-lean coal with some meager coal.

The total methane reserve of the two seams is 495 million m³, with the No. 2 seam containing 241 million m³ and the No. 10 seam containing 254 million m³. From the reserves, the mine reports that 149 million m³ can be drained from the two seams combined (72 million m³ from No. 2 seam, 76 million m³ from No. 10 seam). In 2017, 5.7 million m³ of methane was drained from the mine. The average methane contents of raw coal from seam No. 2 and No. 10 are 9.15 m³/t and 7.69 m³/t, respectively. The residual methane content from the two seams is 2.18 m³/t. Results from the spontaneous combustion testing tendency of coal from the seams No. 2 and No. 10 indicate that both seams are at risk for spontaneous combustion and explosive coal dust.

1.4.1 Location of the TengHui Mine

The mine is located in China's Shanxi Province, situated along the western border of the province in western Diangou village, Zaoling Town, Xiangning County. The geographical coordinates of the mine are 110°34'48" ~ 110°37'05" E and 35°46'22" ~ 35°47'11" N. Figure 1-4 shows the location of the mine.

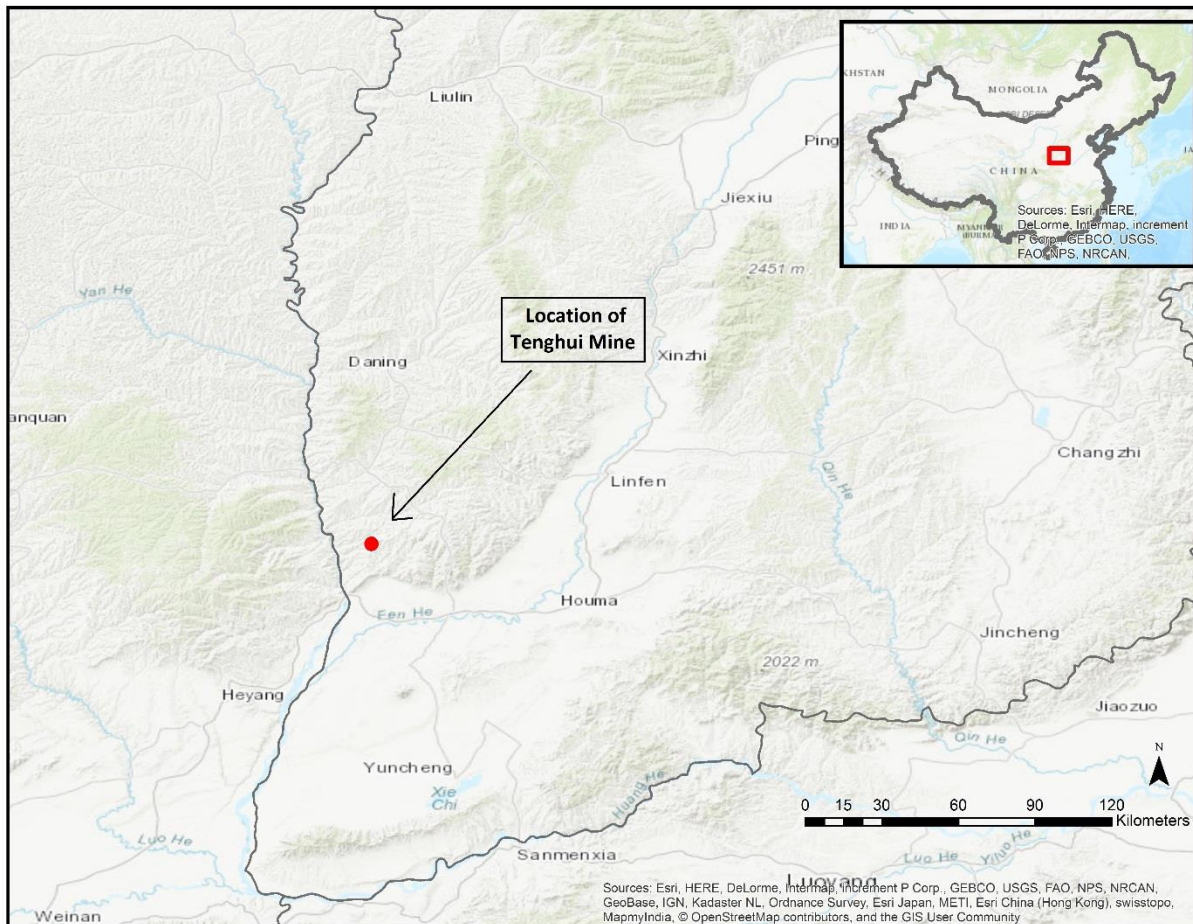

Figure 1-4: Location of TengHui Mine within the prefecture-level city of Linfen.

The TengHui Mine is located near Hejin City in Shanxi Province, which is situated halfway between the major cities of Linfen and Yuncheng in southwestern Shanxi Province. Hejin City is located on the Yellow River and borders Shaanxi province. Outside Shanxi province, either Linfen or Yuncheng would be the closest points of access to Hejin City. Both cities are accessible by train or by air. Travel to Hejin City is principally by overland vehicle such as a car, truck or other motor vehicle. Xian in Shaanxi province is another potential point of entry to access the mine.

The mine is located east of the Yellow River within Diangou village. The coal mine is 50km away from the center of Hejin and it takes approximately 90 minutes to reach the mine from the city center due to limited access via mountain roads. The mine offices, buildings and the primary man and materials shaft are situated in a valley with steep mountain sides surrounding the buildings. There are no villages, households, or surface structures near the working faces of the mine.

1.4.2 Topography and Climate

The terrain of Shanxi Province where TengHui Mine is located is on a plateau whose highland terrain is characterized by low mountains, hills, and basins. The surface of this region is composed of barren loess. The terrain is over 1,500 m above sea level with a northeast-southwest. The Luliang Mountain Range and Yellow River are near the mine.

Shanxi Province is located in a temperate climate zone that has monsoon and dry spell cycles. The province, characterized by monsoons and high altitude, has four distinct seasons with stark temperature difference between the warm and cold seasons. The climate is very dry in the spring and prone to dust storms, while the summer is typically warm and humid. The annual average temperature in Shanxi is 4.2 to 17.0°C (40°F to 63°F). January, Shanxi's coldest month, has average temperatures of between -13°C to -2°C (7°F to 27°F) and July, Shanxi's warmest month, has average temperatures between 20°C to 31°C (68°F to 88°F). Annual average precipitation in Shanxi 400 to 650 millimeters (mm) (Britannica, 2018). The potential for extreme weather such as ice or snow may affect construction activity in this province.

1.4.3 Regional Geology

The mine is situated in the eastern part of the Ordos Basin, a major resource for China that spans 360,000 km². The Ordos Basin is rich in coal, oil, and gas resources. The basin has vast coal reserves of approximately 4 trillion tons of coal, along with substantial amounts of other resources such as oil, natural gas, and uranium. The eastern Ordos basin, where the TengHui Mine is located, is characterized with folds and thrusts that are primarily influenced by the Shanxi folded belt (Guihong, 2016). Most of the coal and gas resources in Shanxi Province are found in the Late Permian and Early Carboniferous strata.

The Shanxi and Taiyuan Formations bear the coal seams that are mined at the TengHui Mine. The Shanxi Formation, deposited during the Lower Permian, is primarily a siliciclastic sandstone traversed with coal seams and has an average thickness of 55 m—the coal deposits here are typically less desirable than those in the Taiyuan formation. Various fluvial systems including braided, meandering, and anastomosing river systems can be found within the sedimentary structures and depositional facies. Numerous fossils can also be found throughout this formation. The abundance of plant fossils found in the Shanxi formation suggests a warm and humid paleoclimate during the deposition. The Taiyuan formation, deposited during the Upper Carboniferous Period, is composed of finer grains that range from muds to fine grained sands. The formation has an average thickness of 120 m and was deposited in a flat lagoon or carbonate platform. Marine fossils can be typically found within the formation.

1.5 Shanxi Coking Coal Group – Owner/Operator of the TengHui Mine

The TengHui Coal Mine is owned by Huozhou Coal Electricity Group, a subsidiary of SCCG. The Huozhou Coal Electricity group has operations in multiple industries, which include coal, electricity, coking, machinery, and construction. The group has ten producing coal mines throughout the Shanxi Province, and has plans to open new mines (SCCG, 2018). SCCG is a large state-owned enterprise based in the city of Taiyuan, within Shanxi Province. Huozhou Coal Electricity Group Co. was founded in 1958 and was eventually incorporated as a limited company in 2000. It became a part of SCCG in 2001.

Established in 2001, SCCG is one of the seven coal conglomerates in China and is the largest Chinese coking coal mining company. In 2016, the group produced 115 million tons of commercial coal and has approximately 100 coal mines in the Shanxi province with a production capacity of 174 million tons per year, along with 28 coal preparation plants, 5 coking plants, 9 coal-fired power plants, and 14 gas and waste heat power plants (SCCG, 2018). Another subsidiary of SCCG, Xishan Coal & Electricity Co., currently operates CMM power projects at three of its other mines.

2 Mine Methane Emissions

Three methane flow streams were summed to derive total methane emissions from the Tenghui Mine: (a) the methane gas diluted in the mine's ventilation system, (b) the methane gas captured by the high vacuum in-seam methane drainage system, and (c) the methane gas captured by the low vacuum gob gas drainage system. Total mine methane emissions between January 2016 and May 2018 (the period of evaluation) ranged between 35-40 m³/min. This equates to about 20 million m³ of methane emitted per year.

2.1 Distribution of Mine Methane Emissions

Approximately half of total mine methane emissions are vented to the atmosphere via the mine's ventilation system. The majority of the balance of the methane gas is captured by a network of in-seam boreholes developed for the purposes of pre-mine drainage or reducing the gas content of the No. 2 coal seam. These in-seam boreholes are connected to a high-pressure vacuum system operating at an average vacuum pump pressure of 41 kilopascal (kPa). A small amount of methane gas (2-3 m³/min) is captured from cross-measure boreholes and large diameter through-pillar boreholes intended to capture gob gas. These boreholes are connected to a low vacuum pressure system running at an average vacuum pump pressure of 37 kPa. Figure 2-1 illustrates the contribution of the three methane flow streams to total mine methane emissions through the period of evaluation.

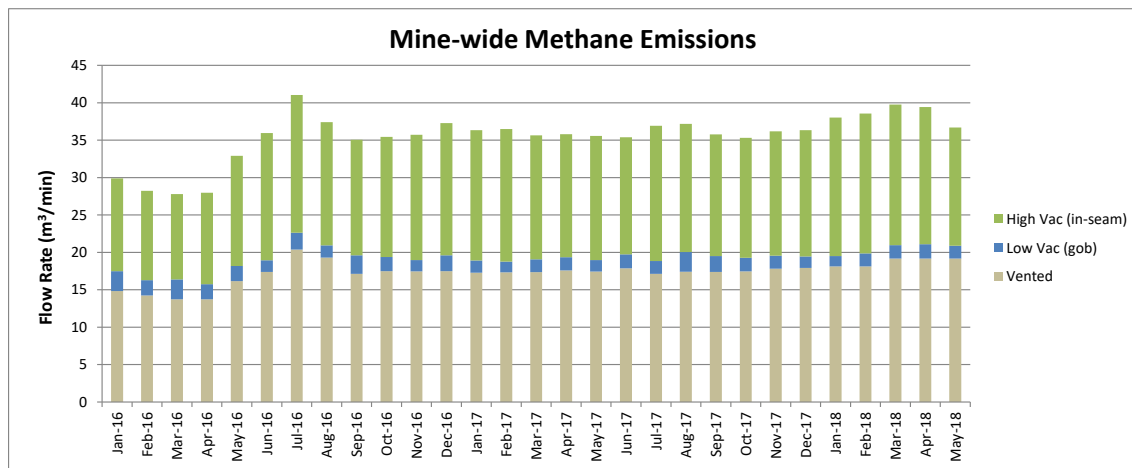

Figure 2-1: Contributions to total mine methane emissions over the period of evaluation.

2.2 Specific Methane Emissions

Assuming an average annual run of mine (ROM) coal production rate of 1.2 Mt per year, the average specific emissions of the mine by year over the evaluation period ranges between 14.4 and 16.4 m³/t as shown on Figure 2-2.

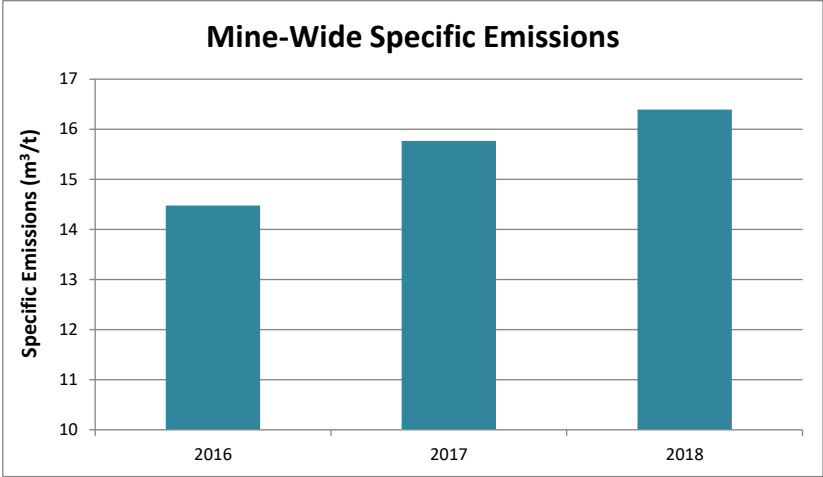

Figure 2-2: Average annual specific emissions for the mine.

3 Methane Drainage and Use at the Tenghui Mine

The mine implements both pre-mine drainage and gob gas drainage techniques and captures low quality CMM unsuitable for use. This section provides an overview of drainage practices, reviews the observations made at the site, and presents further observations made from detailed analysis of available data.

3.1 Current Practices

The mine implements pre-mining and gob gas recovery as separate methane drainage systems, each with dedicated underground gas collection lines, and each with dedicated surface vacuum pumps. Both systems operate at high vacuum pressure using high capacity liquid ring vacuum pumps (100 m³/min capacity each) with the pre-mining system operating at a slightly higher vacuum than the gob gas system (designated by the mine as the “high vacuum system”). Both systems produce methane of too poor quality to use and all of the recovered gas is liberated directly to the atmosphere.

3.1.1 Pre-Mining Drainage

The mine reduces the gas content of the No. 2 coal seam in advance of mains and gateroad developments and in advance of longwall mining with closely spaced in-seam boreholes using rotary drilling techniques. Target gas content reduction of the No. 2 coal seam is 30 percent and generally achieved after 6 months of drainage time.

3.1.1.1 In-Seam Drainage in Advance of Developments

To reduce the gas content in advance of developments the mine maintains short rotary drilled probe holes, 45 to 120 m in length with a 94 mm diameter, in advance of the face and drilled from alcoves specifically constructed for this purpose as shown on Figure 3-1. In this practice, boreholes are continuously drilled ahead of mining, requiring construction of drilling alcoves every 50 m and extension of the gas collection line as part of the development process. Drainage time and gas content reduction in advance of the development heading is minimal.

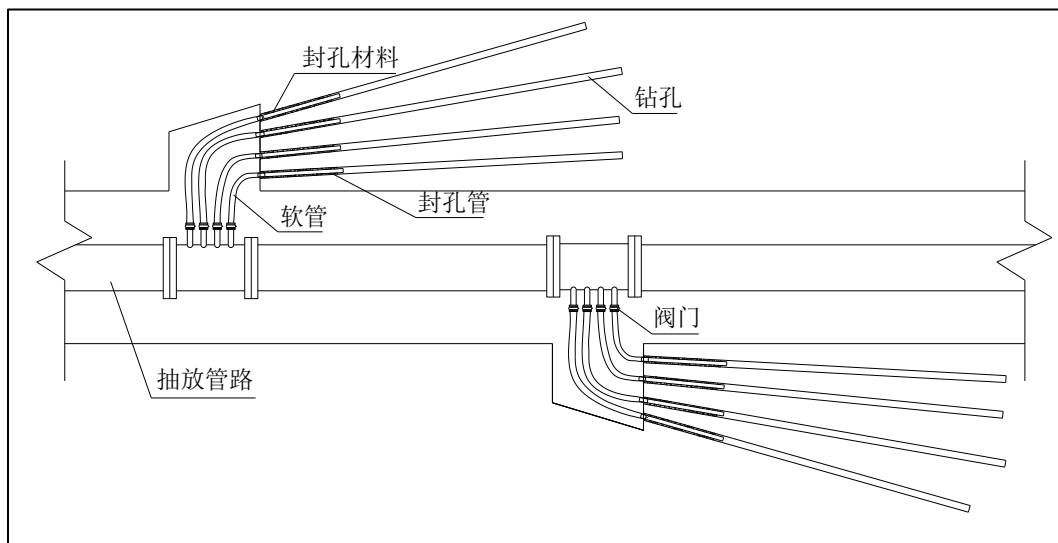

Figure 3-1: In-Seam drainage in advance of developments from alcoves developed every 50 m.

3.1.1.2 In-Seam Drainage in Advance of Longwall Mining

To reduce the gas content in advance of longwall mining, the mine rotary drills boreholes across the longwall panel as gate roads are developed. These boreholes are generally 165 m in length, 113 mm in diameter, and are spaced 4 m apart and off-set in elevation (at the collar) as shown on Figure 3-2.

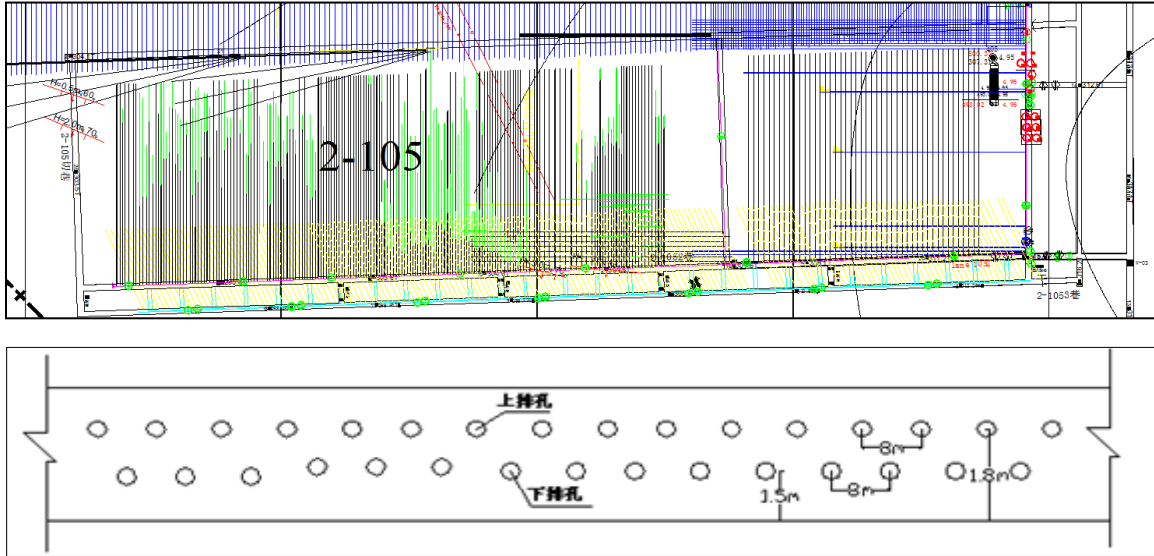

Figure 3-2: Cross-panel in-seam boreholes spaced every 4 m in the No. 2 seam.

The gas production projection for boreholes in the No. 2 seam and the associated gas content reduction as a function of time were derived from the following equation provided by the mine:

$$Q_t = \frac{l}{100} * Q_i * e^{-\lambda t}$$

Where:

Q_t = production rate (m³/day)

l = borehole length (m)

Q_i = initial production rate (m³/day)

λ = attenuation coefficient (day⁻¹)

t = elapsed time (days)

Using this equation for a single 165 m cross-panel borehole in the No. 2 seam, the gas production projections and the associated gas content reduction as a function of time can be derived as shown on Figure 3-3.

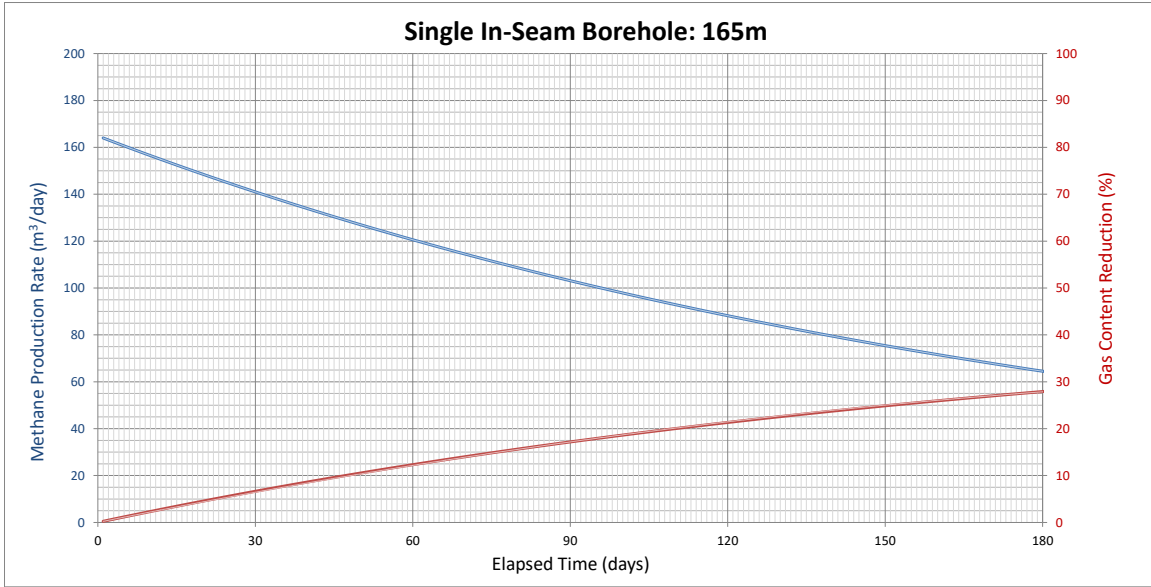

Figure 3-3: Projected gas production and gas content reduction from a single cross-panel borehole in the No. 2 coal seam.

3.1.1.3 Production of Methane from In-Seam Drainage Practices

All of the in-seam boreholes are installed with a collar that is cemented in the coal seam and which is connected to a manifold (typically 6 wellheads are manifolded together) and tied into a 325 mm diameter steel pipeline. The pipeline is comprised of 2 to 3 m sections joined together by gasketed flanges. This high negative pressure pipeline provides for wellhead vacuum pressures greater than 20 kPa and transports the in-seam gas along the main mine return to the surface via a 630 mm diameter pipeline.

Figure 3-4 presents the flow rate of the methane and air mixture, the methane flow rate, and the concentration of the methane, produced from the in-seam boreholes on a mine-wide basis over a 29 month-long evaluation period.

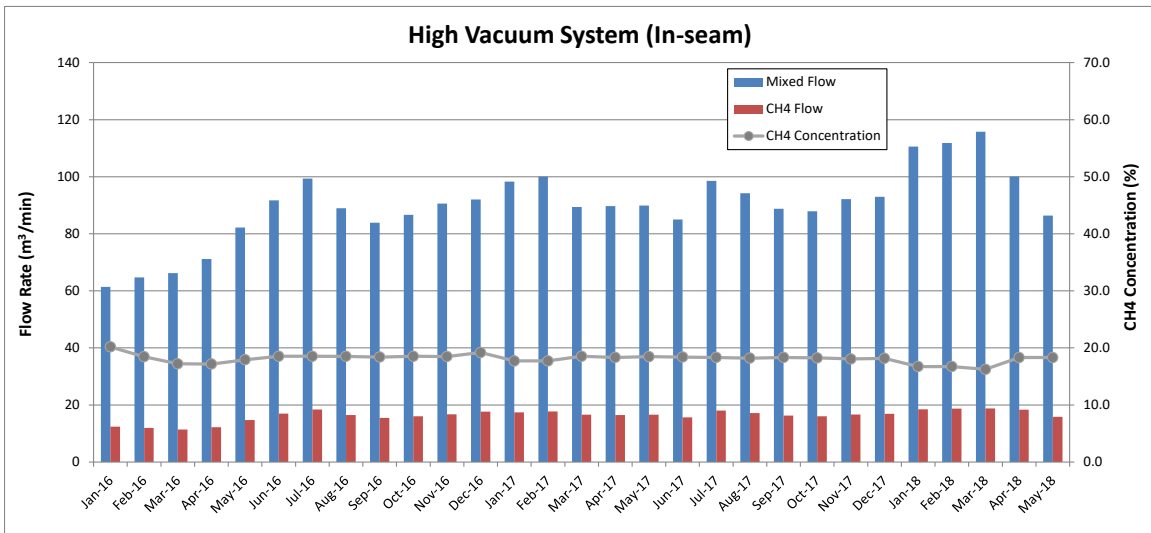

Figure 3-4: In-seam mixed flow rate, methane flow rate, and methane concentration produced by the high vacuum system for the evaluation period.

The average production of methane during the observation period was 17 m³/min at an average concentration of 19 percent methane in air. Average mixed gas flow rate was 90 m³/min.

3.1.2 Gob Gas Drainage

The mine drains gob gas generated during longwall production from frequently spaced cross-measure boreholes, and for some panels, also controls emissions by drawing gas through large diameter boreholes drilled through coal pillars between twin return gateroads.

3.1.2.1 Cross-Measure Boreholes

The mine typically employs both high angle and low angle cross-measure boreholes. These boreholes are drilled in advance of and angled toward the the mining face (60 degrees relative to the tailgate), and project orthoganally between 5 and 25 m into the longwall panel as shown on Figure 3-5. High angled cross-measure boreholes extend from 80 to 105 m in length, and are drilled to elevations of between 50 and 60 m above the top of the No. 2 coal seam, while low angled cross-measure boreholes extend generally 40 m in length and are drilled to elevations of 5 m above the top of the No. 2 seam as shown on Figure 3-6. In some cases the low angled cross-measure boreholes are drilled orthogonal to the gateroad. All of the cross-measure boreholes are drilled to 94 mm diameter and are pre-collared with a dual packer grout system, and are generally spaced 4 m apart.

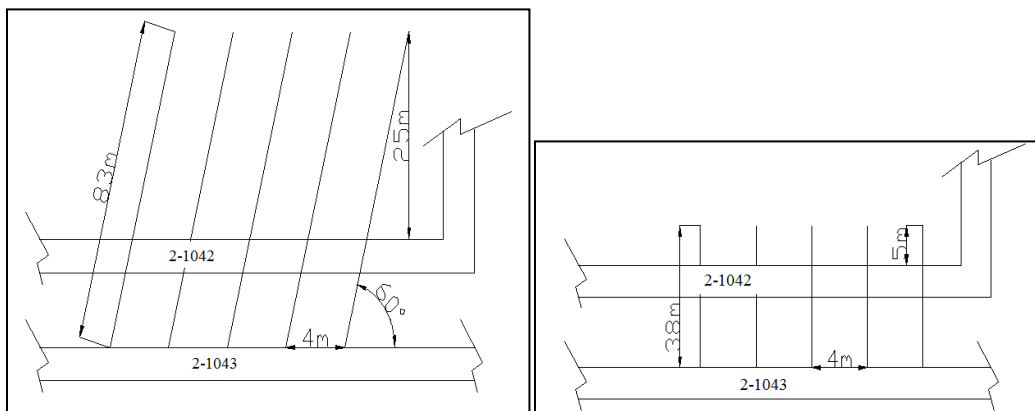

Figure 3-5: Plan view of typical high and low angle cross-measure boreholes.

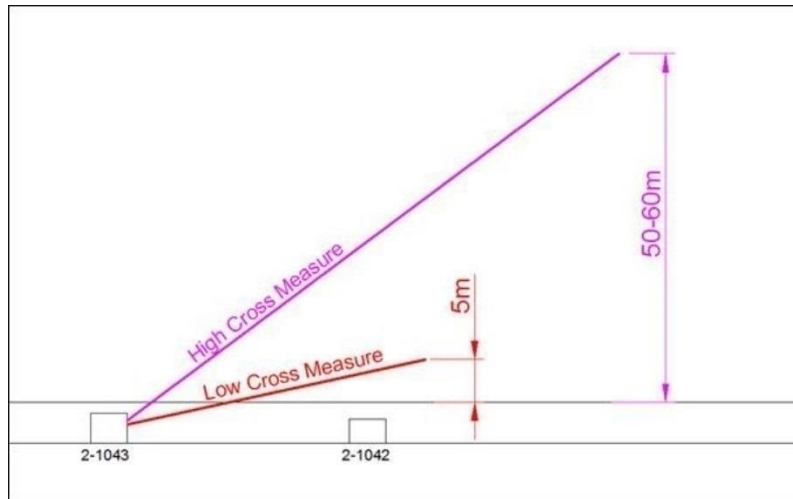

Figure 3-6: Profile view of high and low angle cross-measure boreholes.

3.1.2.2 Large Diameter Pillar Boreholes

For some longwalls, the mine collects/controls gob gas emissions through large diameter boreholes drilled through the coal pillar between two parallel tailgate entries. These boreholes are typically spaced 75 m apart, drilled with a 500 mm diameter, and collared post-drilling to connect them to the gas collection line.

3.1.2.3 Production of Methane from Gob Gas Drainage Practices

All of the cross-measure and large diameter pillar boreholes are connected via manifold or directly to twin 325 mm diameter wrapped steel pipelines suspended from the roof in the tailgate entries. This lightweight 2 mm wall pipeline is comprised of 2 to 3 m sections joined together by gasketed flanges and is operated by the “low negative pressure system”. This system transports the gas along the main mine return to the surface via a separate 630 mm diameter pipeline.

Figure 3-7 presents the flow rate of the methane and air mixture, the methane flowrate, and the concentration of the methane, produced from the gob degasification boreholes on a mine-wide basis over the evaluation period.

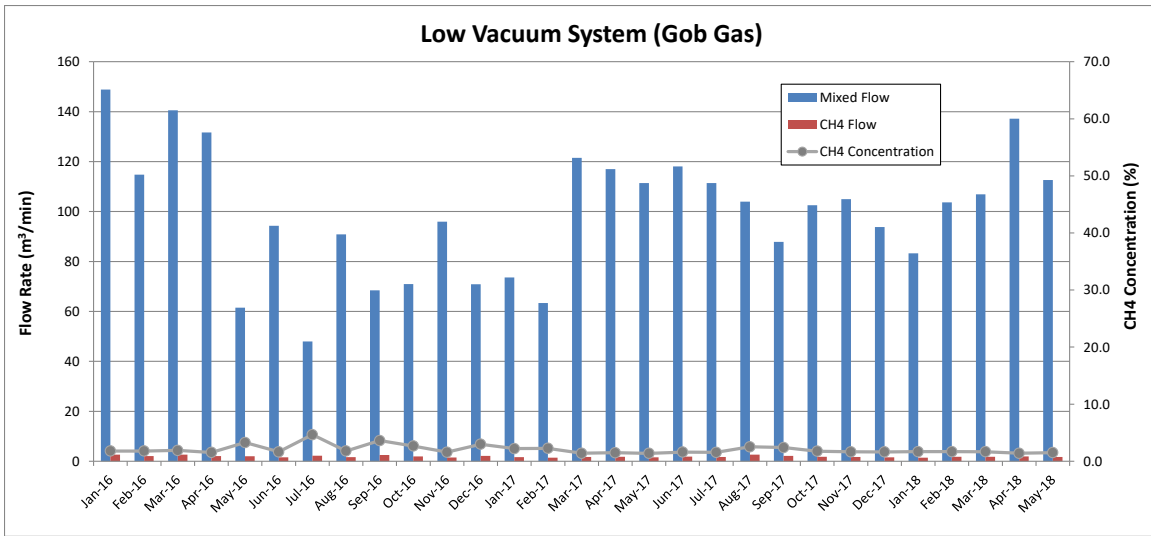

Figure 3-7: Gob gas flow rate, methane flow rate, and methane concentration produced by the low vacuum system for the evaluation period.

The average production of methane during this period was 2 m³/min at an average concentration of 2 percent methane in air. Average mixed gas flow rate was 100 m³/min.

3.1.3 Methane Use

The mine liberates the gas collected by both the high pressure vacuum and low pressure vacuum systems directly into the atmosphere due to poor gas quality. The average methane concentration produced by the combined systems over the evaluation period is 10 percent by volume in air.

3.2 Underground Visit of the Tenghui Mine

A visit of the mine was conducted in June 2018 to review current mining, ventilation, and methane drainage practices. During this visit, the mine had recently begun longwall mining Panel 2-105, and the longwall face had not advanced beyond the width of the panel. Cross-panel boreholes were drilled from the Tailgate entry 1052 and spaced every 4 m, while cross-measure borehole drilling (high angle and low angle, each at 4 m spacing) had just initiated from the 2nd Tailgate entry 1053, along with large diameter boreholes drilled through the coal pillar every 75 m between these entries as shown on the gas drainage schematic on Figure 3-8.

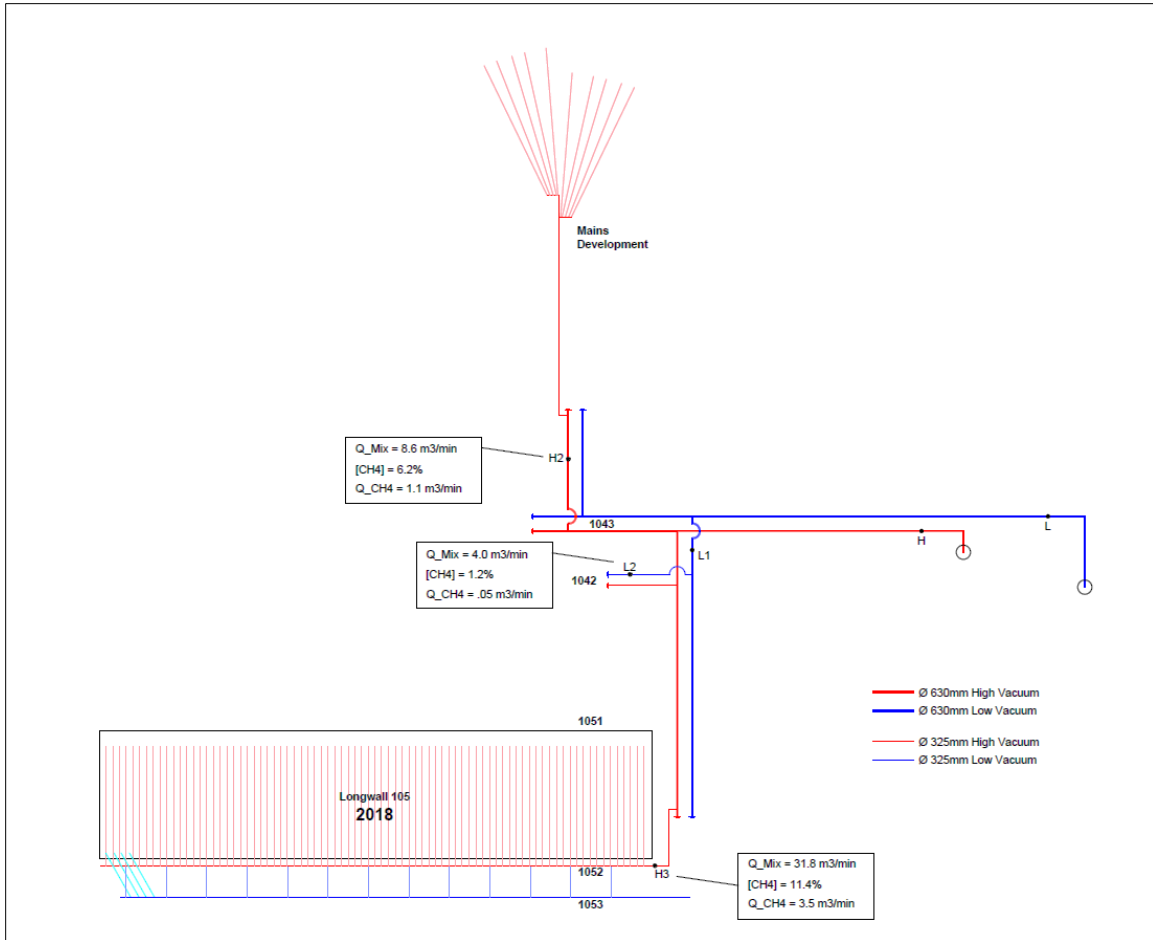

Figure 3-8: Gas drainage schematic of the active mining area at the time of the mine visit.

3.2.1 Pre-Mining Drainage

The cross-panel borehole wellheads were observed along the tailgate entry 1052 and were initially spaced 2 m apart along the longwall face before widening to 4 m per borehole. These cross-panel boreholes were drilled to lengths ranging between 130 and 140 m. Wellheads of 6-boreholes were connected via an HDPE manifold which was connected to a gas/water separator. The recovered gas was routed from the top of the separator to the dual overhead, wrapped steel pipeline (325 mm in diameter). These boreholes were connected to the high negative pressure system which produced wellhead vacuum pressures exceeding 20 kPa, as recorded by the mine on each of the wellheads. Air leakage into the system (visible and audible) was observed around the borehole standpipes, into the ribs through fractures, and into the ribs around rib bolts along the entry. As a result, measured methane concentrations at wellheads ranged widely from 10 percent to 80 percent (measurements were noted on the wellheads). The methane concentration of the gas collected from the wellheads in Tailgate 1052 was approximately 11 percent.

3.2.2 Gob Gas Drainage

The cross-measure boreholes, both high angle and low-angle, were pre-collared starting at the 2nd Tailgate entry 1053 using 75 mm diameter, 9 m in length standpipe and grouted into 115 mm pilot holes. These were spaced every 2 m (high angle to low angle hole). Large diameter (500 mm) boreholes were also drilled through the pillar between the tailgate entries (1052 and 1053) every 75 m. Collar casing was

installed post-drilling and extended approximately 2 m into the borehole for grouting of the annulus between the collar and the borehole. Some of the collar casing had separated at joints after installation. Twin 325 mm diameter pipelines were installed in the 2nd Tailgate entry (1053) and suspended from the mine roof. Pipeline joints were approximately 2 m in length with gasketed flange connections. The gob gas collection system for Panel 2-105 was not in operation at the time of the site visit.

3.2.3 Methane Emissions into the Ventilation System

During the site visit mine personnel measured methane concentrations at various points using hand-held methane monitors. The methane concentration of the air returning from the face of Longwall 2-105 measured between 0.3 and 0.4 percent with no coal production (mining operations were idled for an extended period of time before the visit). This concentration of methane is the result of the methane made from the exposed coal ribs and the longwall face.

3.2.4 Vacuum Station

At the time of the visit, the surface vacuum pump station was operating two high capacity liquid ring vacuum pumps, one for the “high negative pressure” in-seam gas drainage system, and one for the “low negative pressure” gob gas recovery system. Each system was equipped with a second standby liquid ring vacuum pump, each with a capacity of 460 m³/min.

At the time of the visit the high vacuum pressure pump was producing 75 m³/min of 18.6 percent methane-in-air with a vacuum pressure of 36.6 kPa. The low vacuum pressure pump was producing 85 m³/min of 1.3 percent methane-in-air with a vacuum pressure of 35.2 kPa negative pressure. In a typical gas collection regimen, high negative pressure systems are used for gob degasification and low negative pressure systems are used for gas collection from in-seam drainage systems.

3.2.5 Observations from the Site Visit

The mine’s methane drainage systems transport unusable low-quality gas ranging from 0.3 percent to 18.6 percent CH₄, a range that includes methane-in-air concentration levels that are explosive. This is attributed to high vacuum pressures and the sheer number of air leakage points into the underground gas collection systems, including borehole collars and wellhead connections (250 x 3 per 1,000 m longwall), and pipeline connections.

Performance monitoring, for example regulating vacuum pressure based on gas production rates and methane concentration at wellheads, manifolds, or pipeline junctions, is not practiced at the mine.

The underground pipelines are considered explosion proof and are not equipped with integrity monitoring and sectionalizing systems should a breach of the pipelines occur.

The mine is undertaking a tremendous effort to recover a small amount of gob gas (2 percent methane in 90 m³/min), and really using this system in lieu of ventilation as a means to maintain methane concentrations below permissible limits at the longwall face and tailgate intersection during mining.

3.3 Analysis of Underground Methane Emissions

A significant amount of historical information relating to methane drainage system performance and methane concentrations in the ventilation air courses of the mine were provided for analysis.

This information provided the ability to assess the distribution of methane emissions underground and contribution of various activities such as mining of longwall panels versus developments. Data was

provided for specific days in each month from January 2016 through the end of May, 2018. Daily data for each month was averaged and represented as average monthly data.

3.3.1 Longwall Panel 2-104

Methane drainage rates and methane concentrations and airflows were analyzed during mining of Longwall Panel 2-104 (LW 2-104) in the year 2016. LW 2-104 dimensions are 180 m in width and 800 m in length. The No. 2 coal seam in LW 2-104 is 5.2 m thick and mined with top-caving methods whereby the bottom 2.5 m is directly taken by the shearer, and the balance of the seam (2.7 m) overhead is allowed to cave behind the shields and is collected by a separate armored conveyor. A plan view of LW 2-104 is shown in Figure 3-9 with the schedule of longwall face advance by month (started December of 2015, and then completed in March 2017 after an idle period of a two months). For the purposes of this analysis, only the period of generally continuous mining, between January and December of 2016, was evaluated.

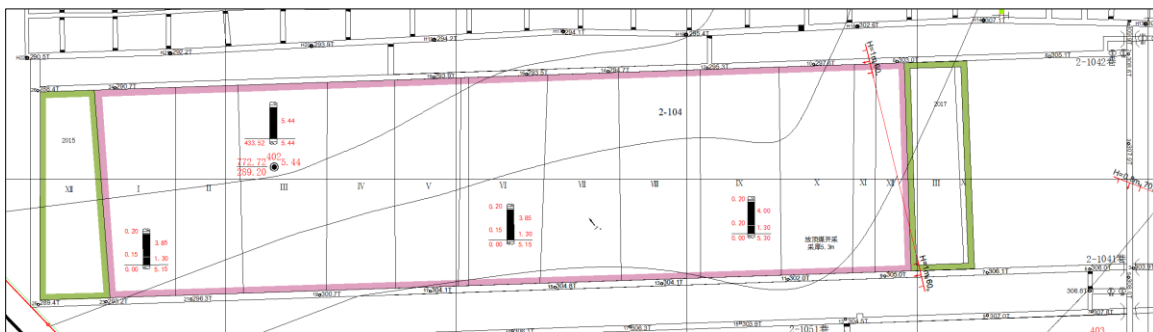

Figure 3-9: Plan view of LW 2-104 with longwall mining timing.

3.3.2 Methane Drainage of LW 2-104

The mine implemented both in-seam pre-drainage methods (cross-panel in-seam boreholes), and gob gas drainage methods (cross-measure boreholes) to control the emissions of methane during mining of LW 2-104.

3.3.2.1 Cross-Panel In-Seam Boreholes

The mine drilled 200 in-seam cross-panel boreholes along the tailgate side (2-1042) of LW 2-104 as this entry was advanced. These boreholes were collared at alternating elevations of 1.5 and 1.8 m in the No. 2 seam and rotary drilled at an average diameter length between 113 mm and 165 m as shown on Figure 3-10 and Figure 3-11. These boreholes produced gas for an average of 6 months to reduce the gas content of the No. 2 coal seam in advance of longwall mining. The in-seam boreholes were connected together by manifolds and connected to a gas gathering system comprised of 325 mm internal diameter pipeline.

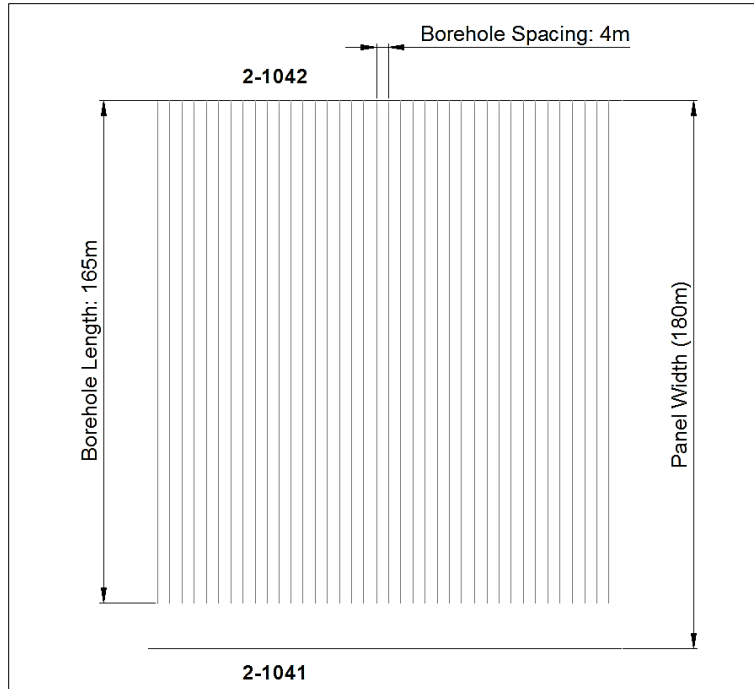

Figure 3-10: Plan view of cross panel drilling scheme for LW 2-104.

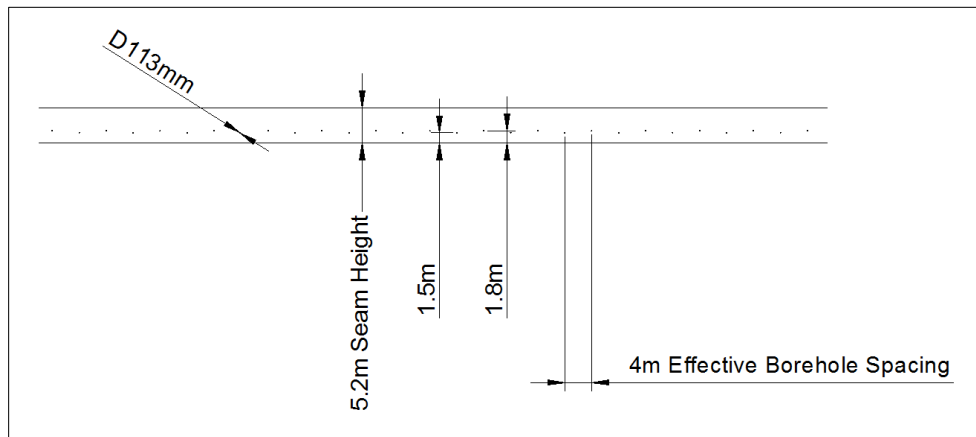

Figure 3-11: Front view of cross panel drilling scheme for LW 2-104.

The methane flow rate from the in-seam cross-panel boreholes approached 9 m³/min at the start of longwall mining, and averaged 5.5 m³/min through the production period as shown in Figure 3-12. As shown on the figure, the gas production rate from the in-seam cross-panel boreholes decreased as mining progressed as the cross-panel boreholes were mined through by the longwall.

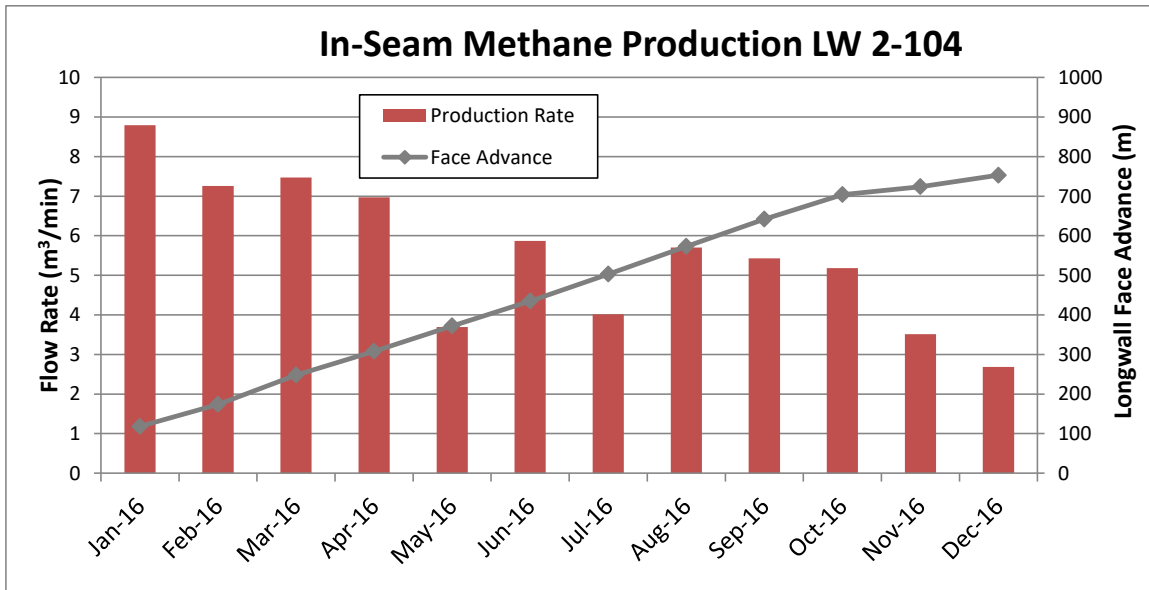

Figure 3-12: Methane production from in-seam cross panel boreholes for LW 2-104.

The methane concentration of the gas recovered from the in-seam boreholes by the “high vacuum” system for LW 2-104 during mining ranged from 10 to 20 percent and was in the explosive range during most of the mining period as indicated on Figure 3-13. This is attributed to air intrusions due to high vacuum, and the sheer number of leakage points (wellheads, number of connections, and collar integrity).

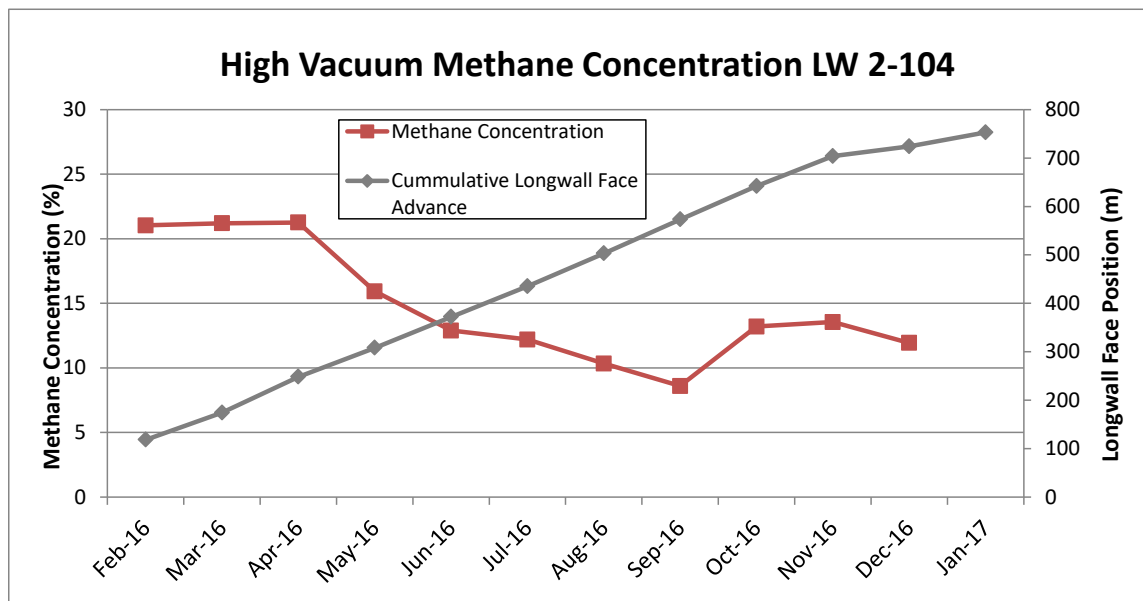

Figure 3-13: Methane concentration from the in-seam cross panel boreholes for LW 2-104.

3.3.2.2 Cross-Measure Boreholes

In an effort to drain gob gas, the mine employed two sets of cross measure boreholes from the LW 2-104 entry 2-1043, as shown in Figure 3-14. The first set of cross measure boreholes were drilled at a high angle (36 degrees) and turned 30 degrees towards the advancing face to reach a target height of 50 m above the No. 2 seam at a length of 83 m. These high angle cross-measure boreholes projected 25 m into the

panel and were spaced apart every 4 m. The second set of cross measure boreholes were shorter, angled upward 12 degrees and 38 m in length to reach a target height of 5 m above the No. 2 seam. The low level holes were drilled perpendicular to 2-1043 and spaced every 4 m.

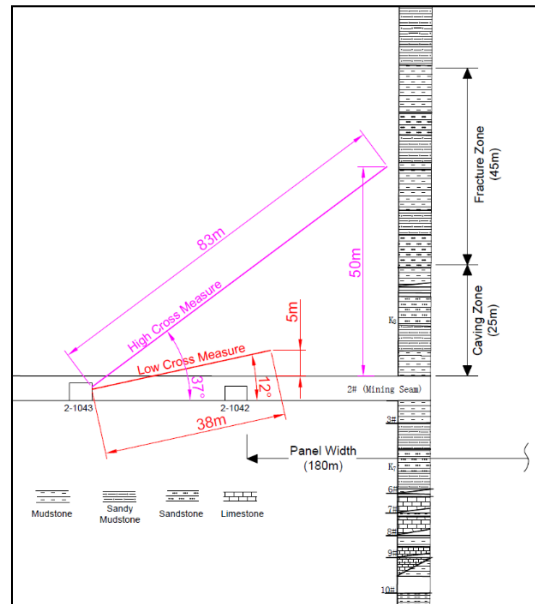

Figure 3-14: Profile view of cross-measure boreholes for LW 2-104.

The cross-measure boreholes were connected to a gas collection pipeline system comprised of up to 2 x 325 mm diameter ID steel pipelines operated under high vacuum.

Methane gas production measured from the “low pressure” vacuum system that was connected to the cross-measure boreholes was very low during longwall mining with average methane flow rates of 1.6 m³/min as shown on Figure 3-15. Gob gas production was the highest near the start of mining, after the face advanced to near the panel width. Following this initial production of gob gas, the methane flow rate from the cross-measure borehole system was relatively steady at between 1 and 1.6 m³/min through mining of LW 2-104. Gob gas production remains generally consistent with this system as generally the same number of cross-measure boreholes are in production at any one time during longwall mining.

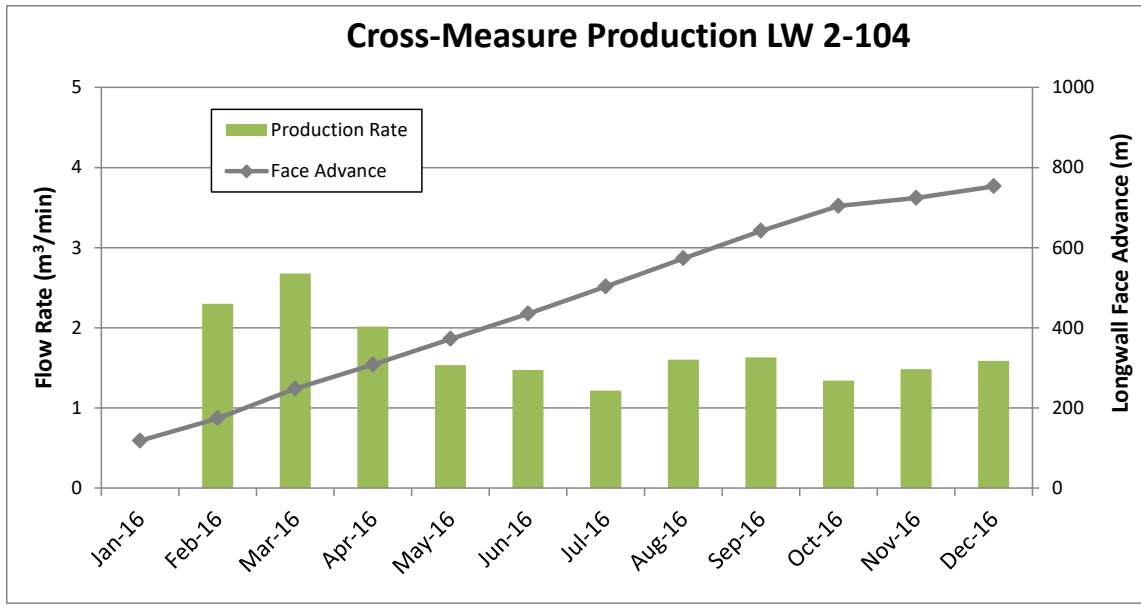

Figure 3-15: Methane production from the cross-measure system during mining of LW 2-104.

The methane concentrations measured in the “low pressure” gas collection system outby of LW 2-104 were also very low during mining, averaging around 2.5 percent as shown on Figure 3-16. This is attributed to high vacuum and the sheer number of potential air intrusion points such as the wellheads and connections, the integrity of the standpipes, and production management practices (isolating cross-measure boreholes that are no longer productive that draw in mostly ventilation air).

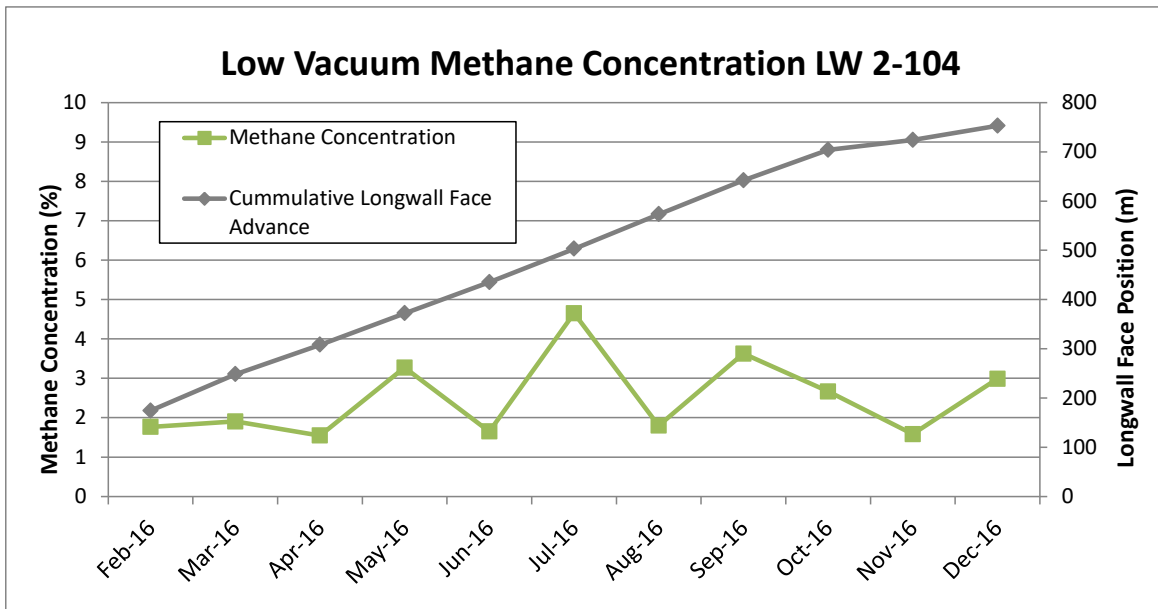

Figure 3-16: Methane concentration of the gob gas produced during mining of LW 2-104.

3.3.3 Ventilation of LW 2-104

The volume of methane liberated into the ventilation system for Longwall Panel 2-104 during the period of mining averages 7.4 m³/min as shown on Figure 3-17. The ventilation air methane emissions trend

similarly to that of the methane captured by the in-seam boreholes. Note that methane emissions into the longwall's ventilation system dropped when the face advance rate slowed near the end of mining in late 2016.

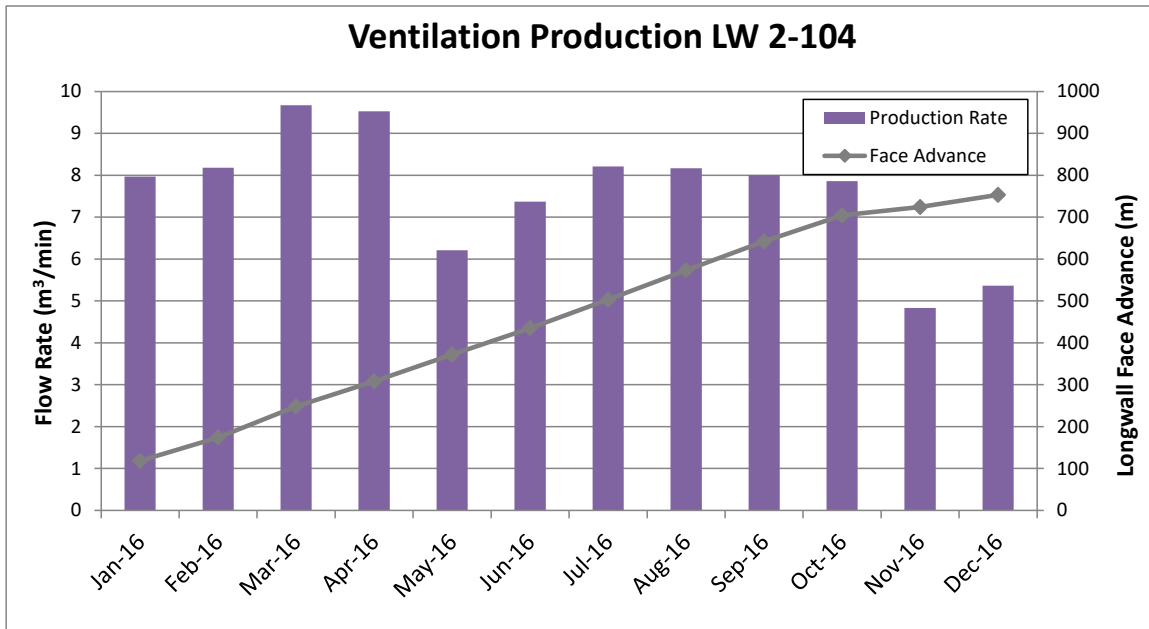

Figure 3-17: Methane gas liberated into the ventilation system for LW 2-104.

3.3.4 Total Methane Emissions from LW 2-104

The total volume of methane liberated during mining of LW 2-104 averaged 14.7 m³/min as shown on Figure 3-18. The distribution of methane emissions remains generally 50 percent captured from in-seam cross-panel boreholes, and 50 percent emitted into the ventilation system. The average overall gas drainage capture efficiency for LW 2-104 is 48 percent as shown on Figure 3-19.

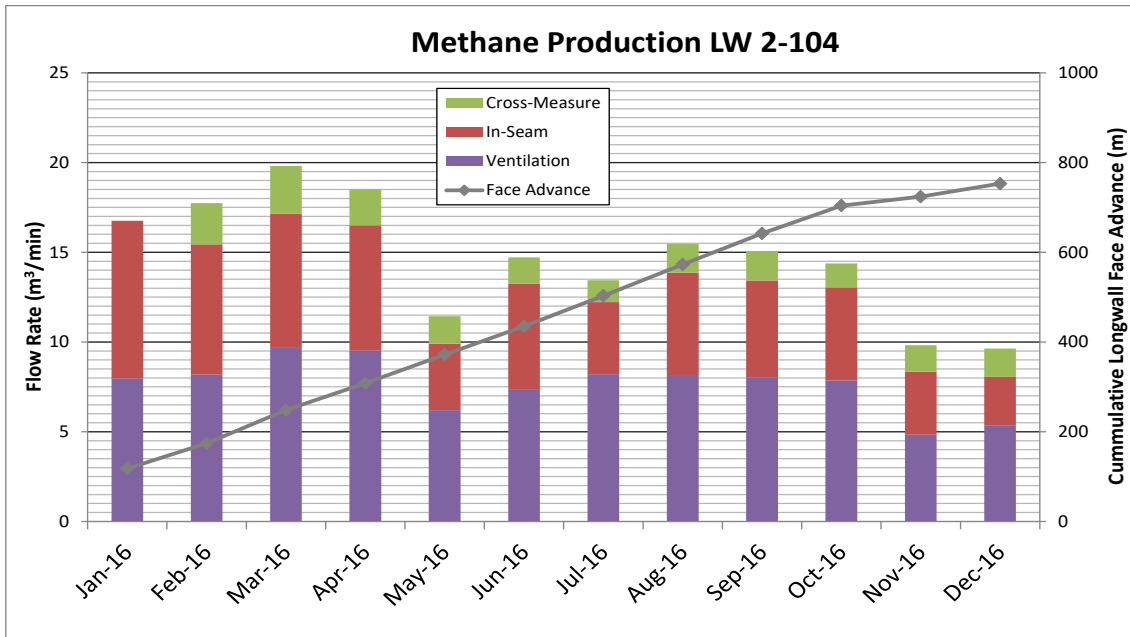

Figure 3-18: Total methane liberated during mining of LW 2-104.

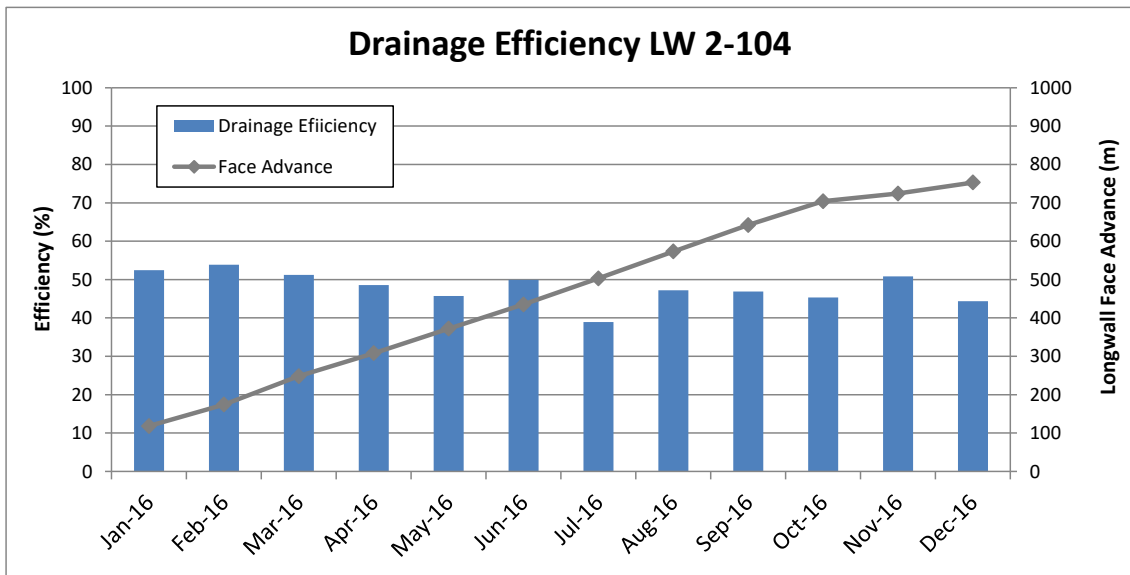

Figure 3-19: Longwall methane drainage efficiency for LW 2-104.

3.3.5 Relative Methane Emissions from LW 2-104

The total LW 2-104 emissions are shown relative to the total mine methane emissions during the period of longwall production on Figure 3-20. On average, LW 2-104 accounted for 45 percent of total mine methane emissions, however, during some months it accounted for less than 25 percent of total mine methane emissions, and during other months, particularly at the start of production, up to 75 percent of total mine methane emissions.

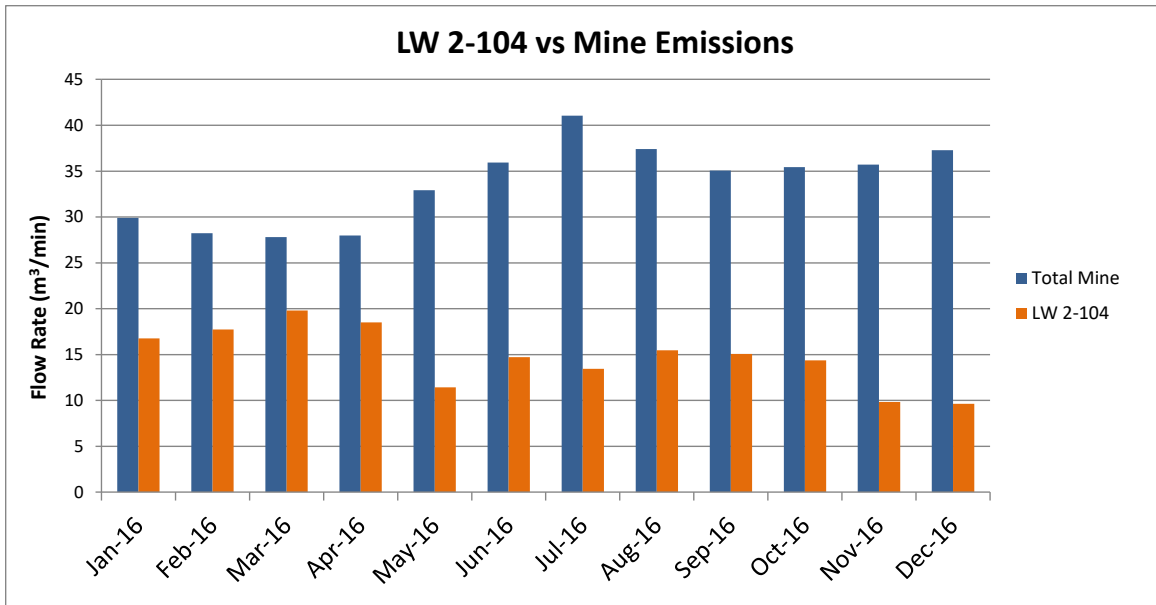

Figure 3-20: Emissions from LW 2-104 compared to total mine emissions.

This trend suggests that methane emissions from mine developments, in-seam boreholes drilled in advance of developments, gas from sealed gobbs/areas, standing ribs and faces, and coal production conveyors account for a significant portion of the emissions from the mine.

3.3.6 The Balance of the Methane Emissions

The balance of the underground methane emissions was determined by the Shanxi Coking Coal group as part of training for preparation of pre-feasibility studies. The 10th of May 2016 was selected, and the group was provided the schematic presented on Figure 3-21, including all of the available data pertaining to methane concentrations and airflows throughout the mine's ventilation system, and gas drainage data for that day. The intent was to derive the methane emissions for each of the working areas of the mine, including gas captured by in-seam boreholes and methane emitted into the ventilation system.

The balance of emissions derived for May 10, 2016, are compiled in Table 3-1 and sum to the total mine emissions of near 29 m³/min.

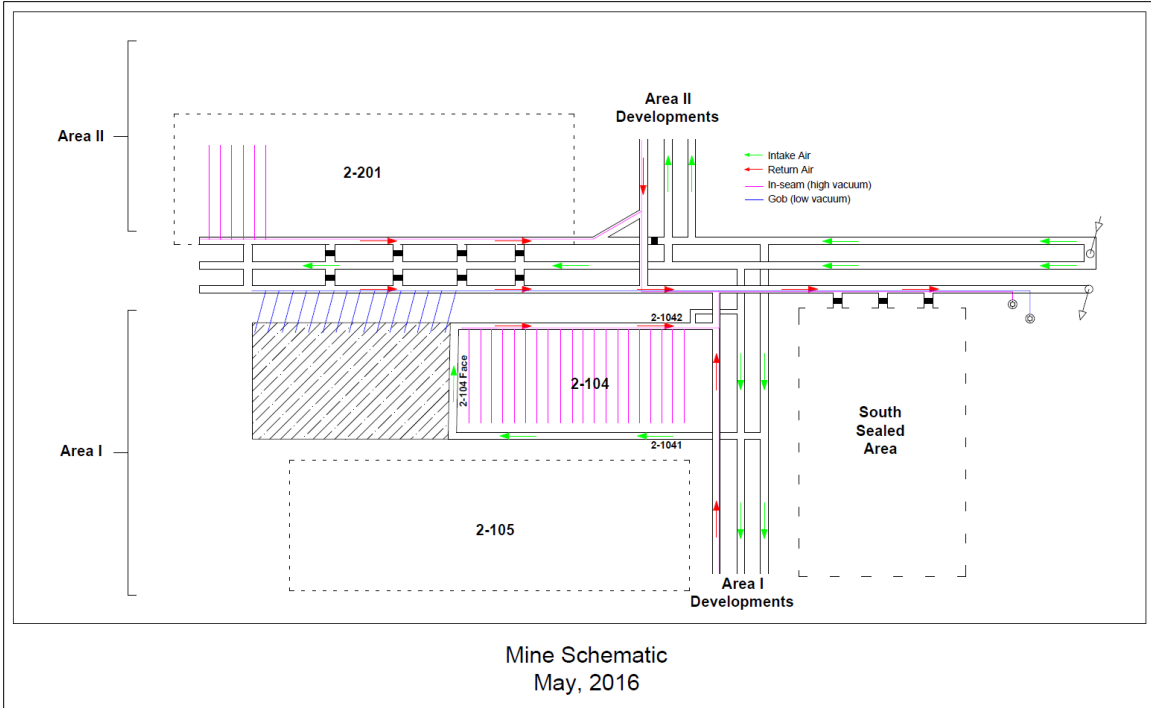

Figure 3-21: Schematic used to derive the underground balance of methane emissions.

10-May-16			
Area		Emissions (m ³ /min)	
Area I Mains	Intake	3.83	3.83
Area I Ventilation	2-104 Gateroads	2.48	8.42
	2-104 Face	5.52	
	Developments	0.42	
Area I Drainage	2-104 In-Seam	2.14	4.19
	2-104 Gob	1.35	
	Developments	0.70	
Area II Ventilation	2-201 Gateroads	0.13	0.32
	Developments	0.19	
Area II Drainage	2-201 In-Seam	9.72	10.47
	Developments	0.75	
South Sealed Area Ventilation		1.29	1.29
Other Ventilation		0.25	0.25
Total Ventilation		14.11	
Total Drainage		14.66	

Table 3-1: Balance of methane emissions underground at the TengHui Mine on May 10, 2016

The analysis indicates that on the 10th of May the methane emissions from the active longwall (LW 2-104), both ventilation air and drainage, contributes to 40 percent of total mine methane emissions (similar to that represented on Figure 3-22).

3.3.6.1 Methane Emissions into the Mine's Ventilation System

The methane emissions into the ventilation system solely from the active longwall face (LW 2-104) as a result of coal cutting and top caving, accounts for approximately 40 percent of the total ventilation air methane emissions, and approximately 20 percent of the total mine methane emissions.

The methane makes its way from the intake shaft to the underground working areas (Area I and II), and from the working areas back to the return shaft, contributes to approximately 20 percent of total mine methane emissions, and is from exposed coal surfaces (standing ribs), seals, and conveyed coal along the main belt line. The balance, approximately 80 percent of the total mine methane emissions, is emitted from the working areas of the mine in Area I and in Area II.

3.3.6.2 Methane Drained

On the 10th of May, 2016, the majority (84 percent) of the methane recovered from pre-mining drainage of the No. 2 seam was from in-seam boreholes developed in advance of developments in Area I and in advance of developments in Area II, and in particular (87 percent), from in-seam cross-panel boreholes developed for the future Longwall Panel 2-201 in Area II.

3.3.6.3 Distribution of Mine Methane Emissions

The contribution to the total mine methane emissions from each of the mining and drainage activities performed on the 10th of May, 2016 is illustrated on the schematic on Figure 3-22.

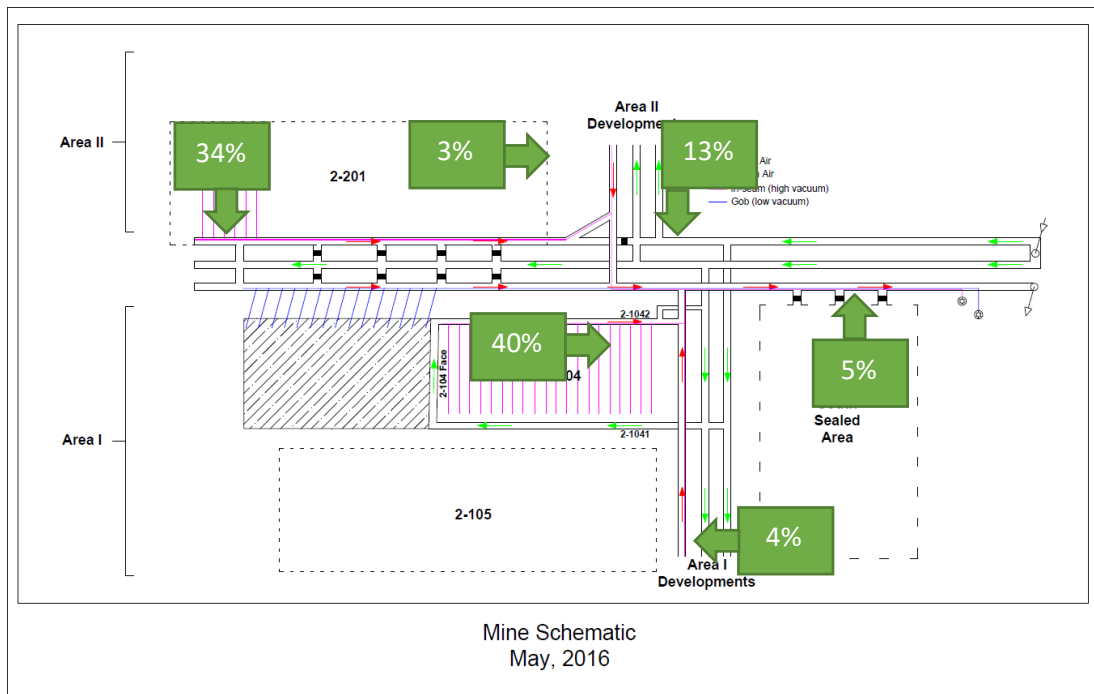

Figure 3-22: The contribution to the total mine methane emissions from each working area.

3.4 Observations and Recommendations

The following observations and recommendations were derived from the visit to the mine and analysis of the available data, including mining and methane drainage plans for the last three years, methane drainage system designs, records of measurements of flow and gas concentration in the underground gas collection system and the mine's ventilation system, including vacuum pump production records.

3.4.1 Mine Methane Emissions

The average daily total mine methane emissions are 53,280 m³/d. The approximate Specific Emissions from the mine are 15.5 m³/t. From the perspective of very gassy mines that liberate in excess of 5 to 10 times this magnitude, the Tenghui Mine is not considered very gassy. The average in-situ gas content of the mining seam, the No. 2, is reported as 9.2 m³/t, and the underlying seam, the No. 10, is reported as 7.7 m³/t. These in-situ gas contents are less than those of coals that are considered very gassy. The No. 2 seam is very thick, 4.9 – 7.5 m, and likely requires gas content reduction through pre-mining drainage to achieve reasonable mine production rates when mined in a single lift, e.g. longwall shearer plus top-caving, as practiced.

3.4.2 Source of Methane Emissions

The No. 2 coal seam is the source of the majority of methane emissions from the mine. 46 percent of total mine methane emissions are from boreholes drilled in the No. 2 seam, 20 percent of total mine methane emissions are from the longwall face during mining of the No. 2 seam, and 20 percent of total mine methane emissions are from ventilating workings in the No. 2 seam (besides the active longwall). The gob gas that is recovered is less than 5 percent of total mine methane emissions and is likely from remnant coal left from top caving rather than overlying gas bearing strata which is limited.

Mines that produce significant volumes of gas from overlying or underlying sources during longwall mining (gob gas) exhibit high specific emissions relative to the *in situ* gas content of the mining seam. In the case of the Tenghui Mine, the specific emissions are reasonably close to the average in-situ gas content of the No. 2 seam (1.6 times greater).

3.4.3 Gas Content Reduction

The No. 2 coal seam is permeability constrained. This is evident from the aggressive gas content reduction practices implemented by the mine, including in-seam boreholes drilled in advance of and maintained ahead of all development headings, closely spaced in-seam boreholes drilled into coal pillars, and closely spaced (2 to 4 m) cross-panel in-seam boreholes.

The measured gas production from approximately 250 cross-panel boreholes in Longwall Panel 2-104, each on average 165 m in length, was 8.7 m³/min (January 2016, Figure 3-22). This equates to an average gas production per cross-panel borehole of .035 m³/min, and an average gas production per m of in-seam borehole of .0002 m³/min. As a comparison, gas production per m of in-seam borehole in a moderately permeable coal seam would be 10 times this rate.

In order to reduce the gas content by 30 percent in 6 months the mine implements a cross-panel borehole spacing of 4 m. This requires a significant number of boreholes, 250 per 1000 m longwall panel, and introduces 250 potential points for air introduction particularly when operated under high vacuum. Alternatively, long in-seam directionally drilled boreholes could be implemented from the ends of the longwall panels in advance of gate development and provide for more drainage time or greater spacing.

This would provide for significantly fewer boreholes and reduce the amount of potential leakage points and facilitate production management.

3.4.4 Gob Degasification

The mine invests a significant amount of effort to capture a marginal amount of methane from the gob during longwall mining. For Longwall Panel 2-104 this volume amounted to less than 5 percent of total mine methane emissions. The key to gob degasification is the ventilation effect of this system. Approximately 98 m³/min of ventilation air is drawn at high vacuum creating a low pressure sink inby and above the longwall face which helps to control the gas fringe away from the methane monitor that is located at the intersection of the longwall face and the tailgate.

Rather than using the currently implemented gob gas drainage system that requires 500 boreholes, 500 wellhead connections, and significant underground pipeline infrastructure to control ventilation methane concentrations near monitoring points, the mine should evaluate and change its longwall ventilation system practices as part of a mine-wide analysis to optimize both ventilation and degasification systems from an effectiveness and economic perspective.

To achieve similar effectiveness from a gob gas recovery perspective, the 500 cross-measure boreholes can be displaced with HGB's drilled longitudinally along the panel axis over the projected rubble zone of the gob and through the projected tension zone alongside the tailgate entry in advance of longwall mining. HGB's are an effective alternative to overlying degasification galleries or cross-measure systems and are implemented routinely in China and in Australia, and occasionally in the U.S. A single HGB could be managed from one collar at high vacuum and draw up to 6 m³/min of medium quality gob gas and provide equivalent gob gas control at a significantly lower cost than current practices.

3.4.5 Underground Gas Management

Minimizing wellheads by implementing directional drilling solutions, both in-seam and HGB's, will facilitate the implementation of performance monitoring and control of the underground gas collection system. Wellhead vacuum needs to be monitored and then controlled based on measurements of gas quality and gas production to optimize system performance and to prevent transport of explosive mixtures of methane and air. This can be performed manually on a routine basis, or by implementing permissible automated control systems.

Permissible automated systems can also control water accumulation in pipelines operating under high vacuum to reduce restrictions and improve overall system performance.

Implementing HDPE pipe which can be fused in advance, or underground in intake air courses, rather than gasketed and flanged steel sections of pipe will further minimize the number of potential points of air intrusion into the underground pipeline and lead to improved recovered gas quality.

Modern gathering lines are monitored for integrity and are equipped with sectionalization features that isolate zones of the pipeline should a breach occur as a result of mining equipment or roof falls. Typically, pressurized tubing is connected to the pipeline and to pneumatic valves at pipeline intersections and wellheads that are designed to fail close should the integrity line break and lose pressure.

4 Recommended Improvements to Methane Drainage and Use Practices

Recommendations were derived for both in-seam drainage and gob degasification that would increase methane drainage effectiveness, improve recovered gas quality, reduce methane drainage costs, and increase the value of the gas.

These recommendations were based on the observations outlined following a visit to the mine and an evaluation of available data, as presented in the previous section.

4.1 Recommended In-Seam Methane Drainage Approach

Directional drilling delivers an in-seam drainage solution that reduces the number of wellheads and potential points of air leakage into the gas drainage system, and provides for longer drainage times to further reduce residual gas contents.

Long directionally drilled boreholes placed in advance of and flanking mine developments are recommended rather than rotary drilled boreholes developed and maintained in advance of every mine heading and developed from alcoves mined specifically for this purpose.

Long directionally drilled boreholes that can be installed from main entries, significantly in advance of gate road developments, and drilled along the longitudinal axis of longwall panels are recommended rather than rotary drilled cross-panel boreholes that are implemented as the tailgate entries are advanced.

4.1.1 Direct Drilling Approach

Reducing the gas content of both the No. 2 and the No. 10 seams in advance of mining with directionally drilled boreholes requires detailed knowledge of future mining plans. The design needs to consider mine infrastructure (drilling locations), drainage time, borehole spacing, gas content reduction requirements, and proper collar installation.

4.1.1.1 Borehole Planning

Long in-seam directionally drilled boreholes can be implemented from mains and sub-mains and placed in service significantly in advance of planned developments or gate roads. Directionally drilled boreholes need to be planned based on available time to drain, and desired residual gas content. For the mine, the long directionally drilled boreholes can be planned based on spacing required to achieve a 30 percent reduction in residual gas content. This figure is based on the theoretical reduction attained by current practices in the No. 2 seam as presented in Section 3.1.1 and serves as good starting point.

4.1.1.2 Borehole Collars

When implementing directional drilling methods, multiple borehole branches may be drilled from a single collar, which greatly reduces the number of required wellheads. This justifies spending time to install proper borehole collars of adequate length that are centralized, effectively grouted into place, and pressure tested to sustain 1.5 x anticipated shut-in pressures. Significantly fewer wellheads will facilitate management of vacuum as a function of methane concentration and gas flow rate which is required to optimize drainage system performance.

4.1.1.3 Adjacent Seam

In order to maximize borehole spacing, drainage time, and gas content reduction, and minimize overall drilling requirements, the lower No. 10 seam (43 to 52 m below the No. 2 seam) may be drilled years ahead of mining by directionally drilling from the current mining level on the No. 2 seam. In this concept, in-seam boreholes are directionally steered down through the inter-burden into the No. 10 seam, extended through the coal seam, and drilled to intercept vertical wells as shown on Figure 4-1. These vertical wells are internal to the mine and are developed from No. 2 seam workings down to just below the No. 10 seam. These vertical wells are intercepted with directionally drilled boreholes using magnetic vector technology. This process involves directional drilling to within 50 m of the vertical well using an accurate directional drilling guidance system. At this point, since the guidance system has some associated azimuthal error (typically +/- 1 Degree), a rotating magnet is placed behind the directional bit and a transducer is lowered into the vertical well to guide the interception. Several directionally drilled horizontal boreholes may intercept a single vertical well. Formation water and drilling fluids collected in the vertical well from the down-dip directional boreholes are produced with pumps installed in the sumps of the vertical wells. All water production and all gas production would be managed from the No. 2 level which contains all of the underground gas collection infrastructure.

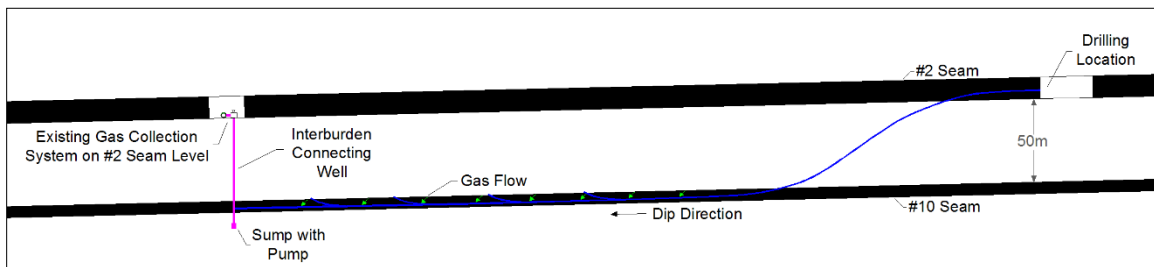

Figure 4-1: Profile view of in-seam drainage concept for the No. 10 seam.

4.1.2 Future Mining Plans

In order to derive a methane drainage plan for the mine, future mining plans were generated for the period between 2019 and 2029 based on planning information from the mine, and extrapolation assuming consistent coal production rates and mining technique.

4.1.2.1 No. 2 Seam Plans

Currently, the mine produces about 1.2 Mt of coal per year, all of which is from the No. 2 seam. Future longwall panels were identified and dimensions provided by the mine (Table 4-1) through 2020. Assuming the same coal production rate, two additional longwall panels were extrapolated for mining through 2024 after which the No. 2 seam reserves would be depleted as shown on Figure 4-2.

4.1.2.2 No. 10 Seam Plans

Assuming that current coal production levels are sustained during future mining of the No. 10 seam, a total of five panels were extrapolated for future mining through the year 2029 as shown on Figure 4-3.

Panel	Width (m)	Length (m)
2-203	100/60	922
2-202	165	1,170
2-206	78/100/128/170/200	1,372

Table 4-1: Longwall panel dimensions for future mining in the No. 2 seam.

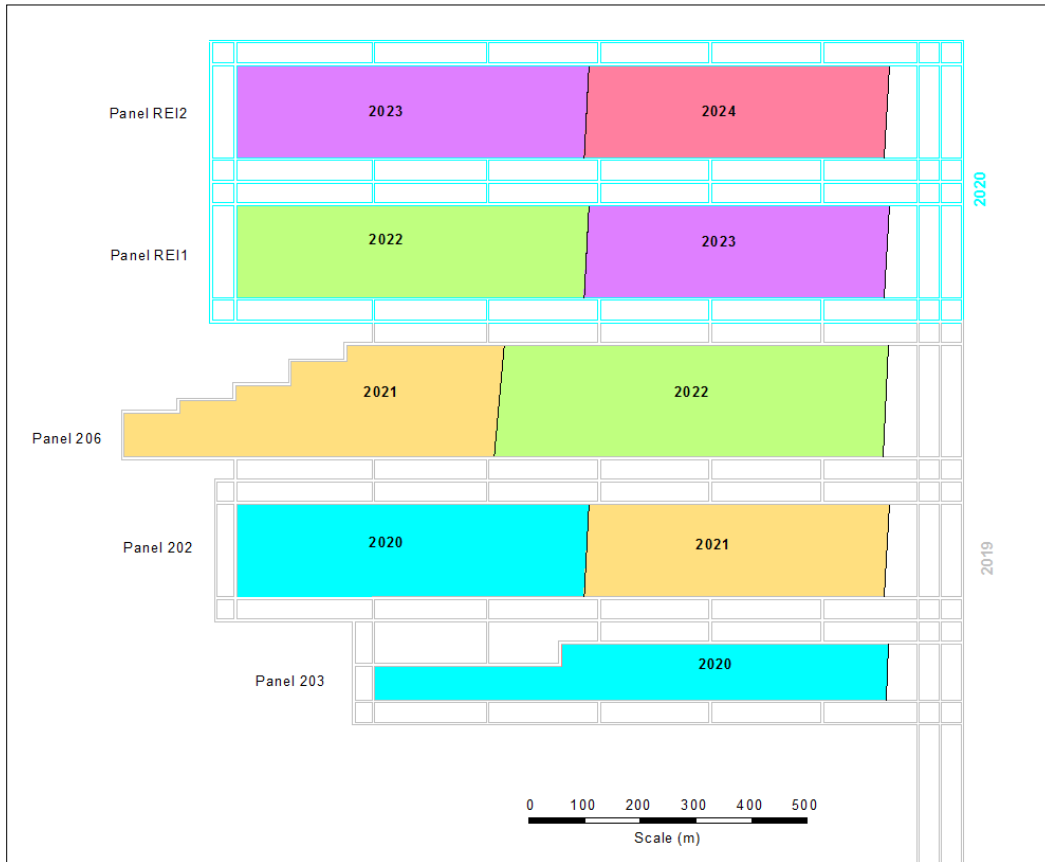

Figure 4-2: Future mining projections in the No. 2 seam.

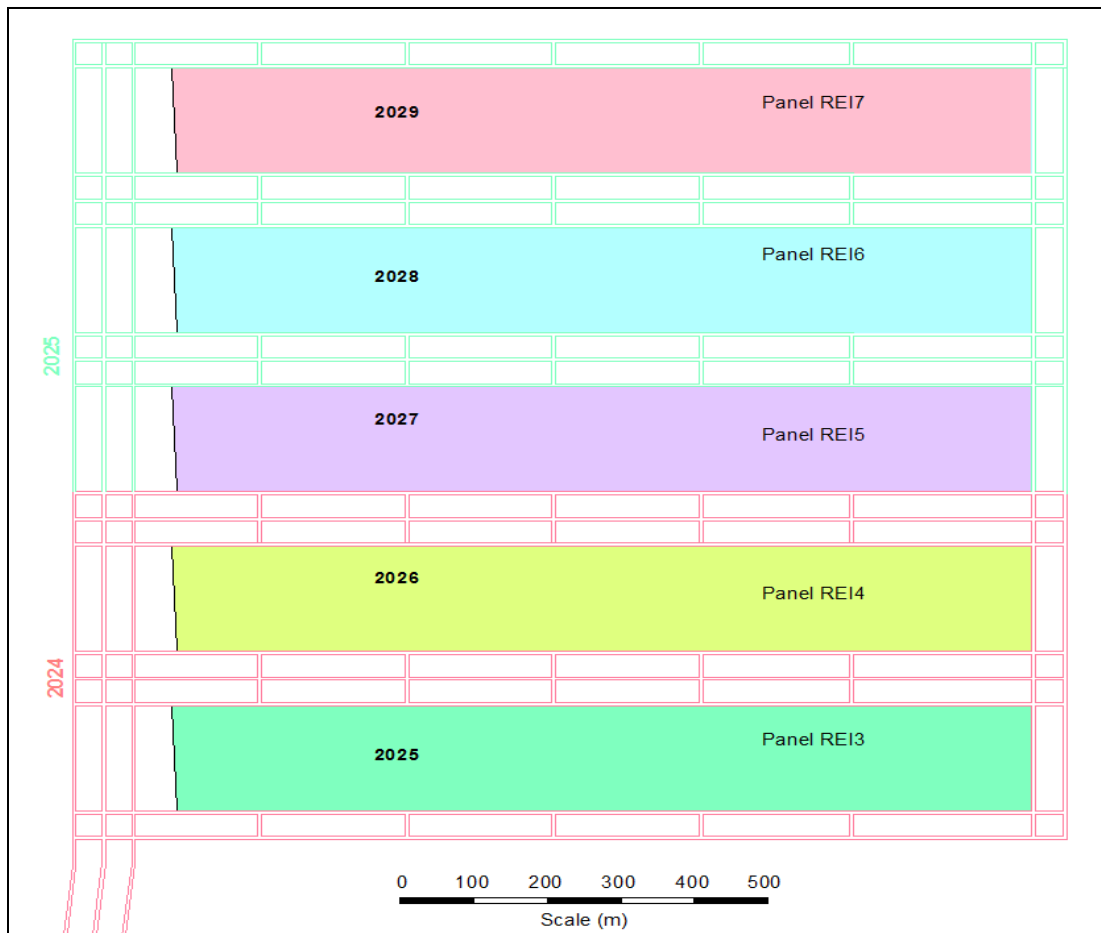

Figure 4-3: Future mining projections in the No. 10 seam.

4.1.3 Reservoir Modeling to Correlate with Existing In-Seam Borehole Production

Reservoir modeling was performed to aid in deriving the in-seam methane drainage plan for the mine. All of the numerical models used for this effort were based on the initial Correlated Reservoir Model.

4.1.3.1 Reservoir Modeling Software

COMET2, a three-dimensional, two-phase finite difference fractured reservoir simulator developed by Advanced Resources International was used. This model considers the three processes of gas flow through coal, desorption from the coal surfaces in the micro-pores to the coal matrix, diffusion from the coal matrix to the cleat and natural fracture system, and Darcy flow through the cleat and natural fracture system as a result of pressure depletion.

4.1.3.2 Correlated Reservoir Model

An initial reservoir model was developed to correlate predictions of gas flow and gas content reduction as a function of time with theoretically predicted methane production from the in-seam boreholes implemented at the mine.

Correlation modeling was performed with available reservoir characteristics of the No. 2 seam and approximate or analogous input data to simulate and match the theoretical production decline curve for the single cross-panel borehole shown on Figure 3-3. The reservoir model incorporated zero-flow

boundary conditions 2 m on either flank of the borehole to represent a line between mirror images – e.g. adjacent boreholes on each side of the model, spaced 4 m apart. The length of the model was that of the width of the longwall panel (2-104) as shown in plan and profile view on Figures 4-4 and 4-5, respectively.

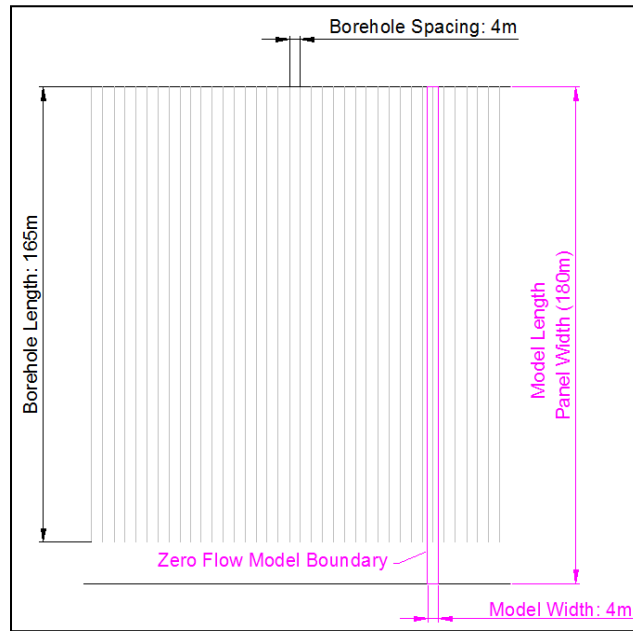

Figure 4-4: Plan view of the No. 2 seam correlation model.

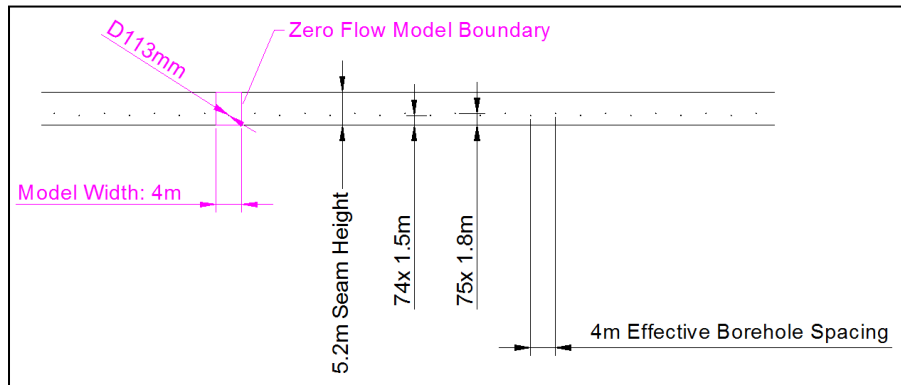

Figure 4-5: Profile view of the No. 2 seam correlation model.

4.1.3.3 Critical Reservoir Parameters

Critical reservoir parameters were adjusted until the predicted gas production rate for the single in-seam cross-panel borehole matched the theoretical prediction as a function of drainage time as shown on Figure 4-6.

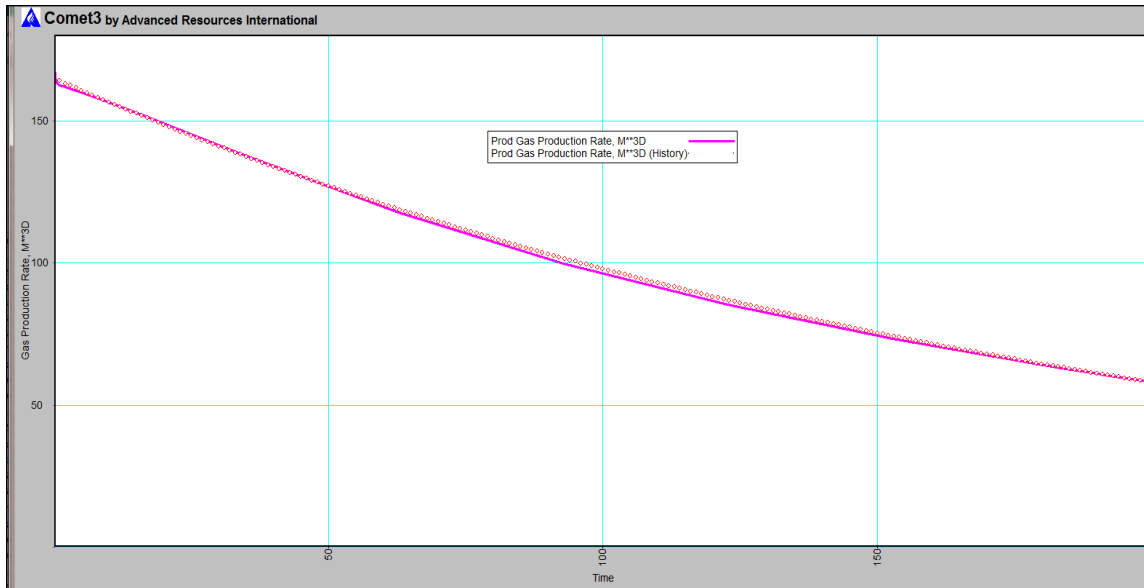

Figure 4-6: Match of the theoretical gas production rate from 1 x 165 m cross-panel borehole spaced 4 m apart.

The values of the critical reservoir parameters which were varied to achieve the match during correlation modeling are presented in Table 4-2.

Parameter	Value
Permeability (isotropic)	.075 mD
Cleat Porosity	1.7%
Sorption Time	10 days
Langmuir Volume	48.23 m ³ /m ³
Langmuir Pressure	2,000 kPa
Pressure Gradient	9 kPa/m

Table 4-2: Critical reservoir parameters derived for the No. 2 seam.

4.1.4 Reservoir Modeling to Derive Borehole Spacing as a Function of Drainage Time

Using the critical reservoir parameters derived from the Correlated Model, multiple reservoir models were developed to simulate long directionally drilled in-seam boreholes placed along the longitudinal axis of future longwall panels at various spacings. The intent of this exercise was to determine the drainage time required to achieve the 30 percent residual gas content reduction target as a function of borehole spacing.

4.1.4.1 Reservoir Models

Plan and profile view illustrations of the models developed to simulate the 1,000 m long 96 mm diameter directionally drilled boreholes are shown on Figures 4-7 and 4-8, respectively. As with the Correlated Model, zero-flow boundaries were created along the flanks of the borehole such that the width of the reservoir model was equal to the borehole spacing. Apart from seam thickness, depth, and reservoir

pressures, the reservoir characteristics derived from the correlation effort performed for the No. 2 seam, were used for reservoir models developed for the No. 10 seam.

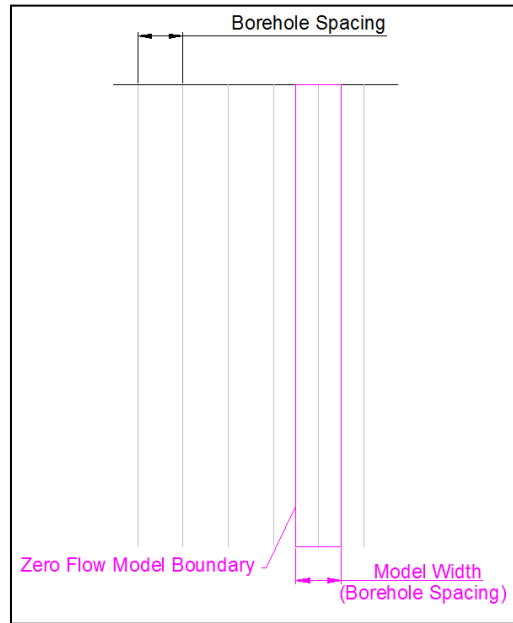

Figure 4-7: Plan view of long hole spacing models.

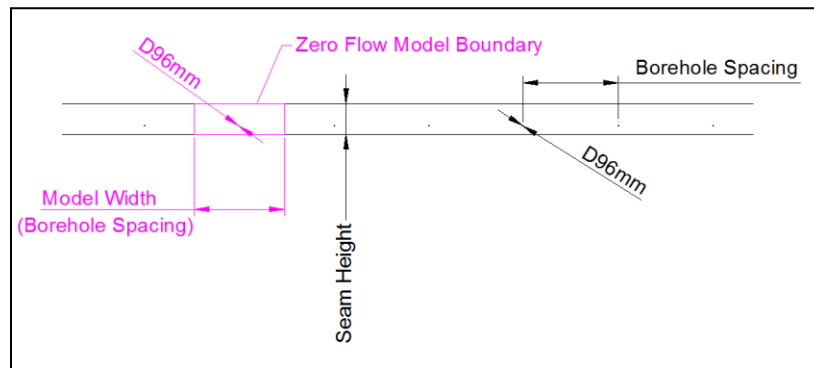

Figure 4-8: Front view of long hole spacing models.

4.1.4.2 In-Seam Borehole Production Projections

Reservoir models were developed for 1,000 m in-seam boreholes spaced 8.5, 12, 16, 20, 24, and 40 m apart in the No. 2 seam, and 37, 47, and 57 m apart in the No. 10 seam. The models predicted borehole gas flow rate and gas content reduction as a function of time for a 5-year period as shown on Figures 4-9 and 4-10 for the No. 2 and No. 10 seams, respectively. The drainage time required to reduce the residual gas content by 30 percent, and the average gas production rate for each in-seam borehole configuration during that period, were derived from the numerical models and presented in Tables 4-3 and 4-4 for the No. 2 seam, and No. 10 seam configurations, respectively.

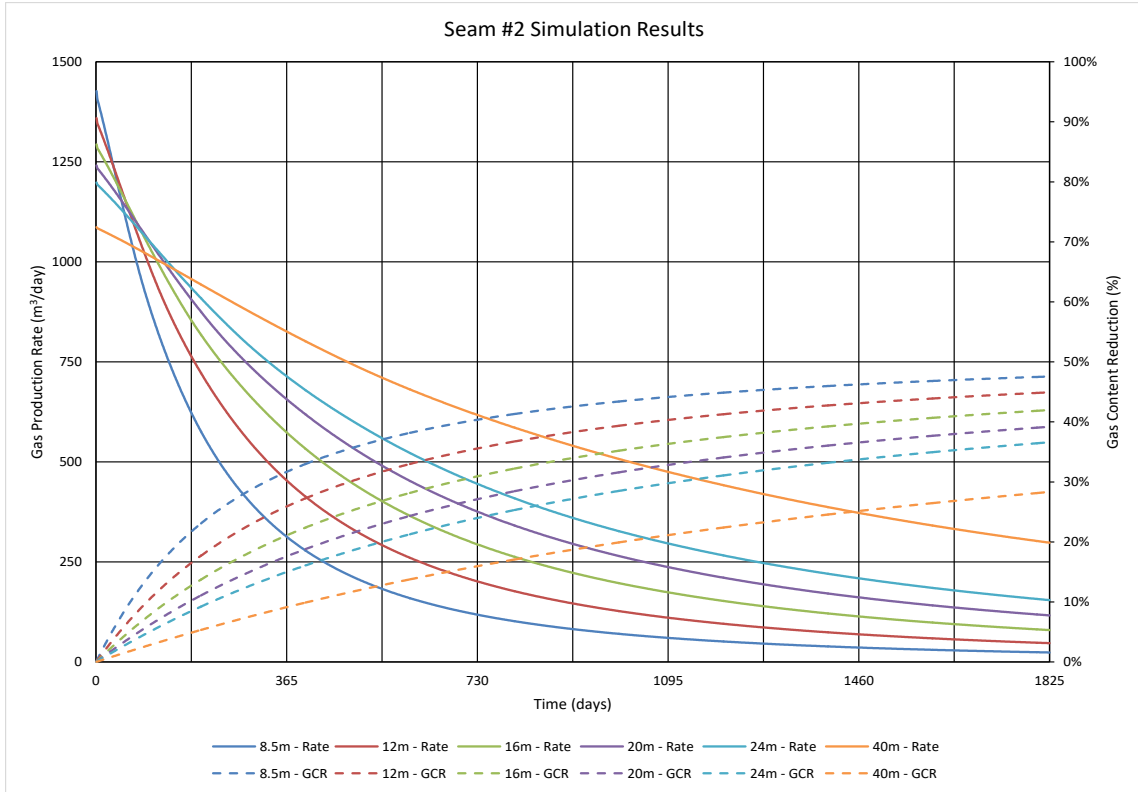

Figure 4-9: Results of gas content reduction versus borehole spacing analysis in the No. 2 seam.

Spacing (m)	Time (years)	Gas Content Reduction (%)	Average Methane Flow Rate (m³/day)
8.5	1	30	686
12	1.5	30	651
16	2	30	639
20	2.5	30	627
24	3	30	618
40	5	50	590

Table 4-3: Drainage time and avg. gas production rates vs. borehole spacing in the No. 2 seam.

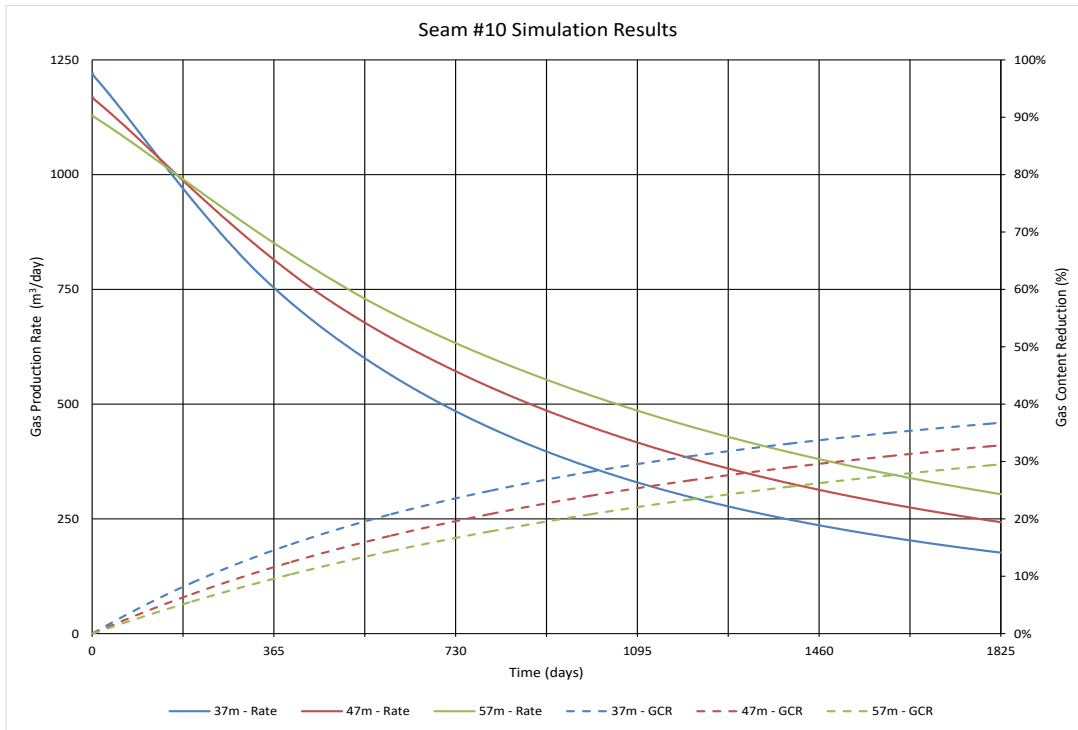

Figure 4-10: Results of gas content reduction vs. borehole spacing analysis in the No. 10 seam.

Spacing (m)	Time (years)	Gas Content Reduction (%)	Average Methane Flow Rate (m³/day)
37	3	30	654
47	4	30	626
57	5	30	606

Table 4-4: Drainage time and avg. gas production rates vs. borehole spacing in the No. 10 seam.

4.1.5 Pre-Mining Methane Drainage Plans for the No. 2 and No. 10 Seam Workings

Based on the borehole spacing results from the numerical modeling effort, an in-seam directional drilling borehole plan was developed for the future mining projections in the No. 2 and No. 10 seams.

4.1.5.1 No. 2 Seam Workings

Long directionally drilled boreholes were planned in advance of mains, gate roads, and longwall panels using the mining schedule for the No. 2 seam workings through the year 2024 presented on Figure 4-2. The spacing requirements for the in-seam boreholes were derived by comparing the time available for gas drainage based on the mining schedule (and directional drilling schedule) with the time required to reduce the residual gas content by 30 percent per the reservoir modeling results (Figure 4-9 and Table 4-3). This pre-feasibility study assumes that directional drilling will initiate in 2019 with flanking boreholes developed in advance of the main entries, and subsequent boreholes flanking Panel 203 gate roads and drilled longitudinally to reduce the gas content of the longwall panel. Based on the mining and drilling schedule, minimal drainage time is available, and a borehole spacing of 8.5 m will be required as shown

on Figure 4-11. As directional drilling begins to outpace mining and more drainage time is available, borehole spacing increases, minimizing annual drilling requirements during the later years as shown on the drilling schedule in Table 4-5. Overall, the No. 2 seam pre-drainage drilling plan requires a total of 72,000 m of drilling, all of which could be performed from just 32 borehole collars.

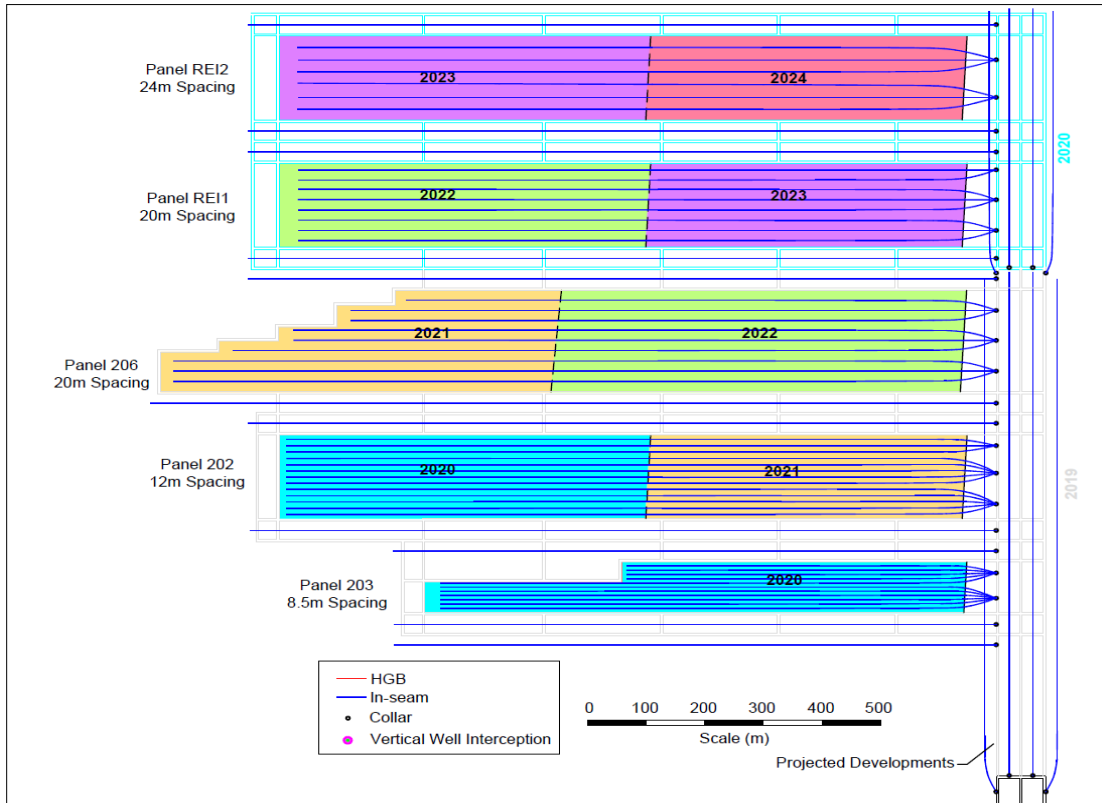

Figure 4-11: Plan view of in-seam methane drainage approach in the No. 2 seam.

No. 2 Seam: In-Seam Drilling Requirements		
Year	Area	Annual Drilling (m)
2019	Mains Development	4,000
	Panel 203	12,230
	Panel 202	18,271
	Panel 206	12,552
2020	Mains Development	2,055
	REI1	12,069
	REI2	9,688

Table 4-5: Pre-mining directional drilling schedule for the No. 2 seam.

4.1.5.2 No. 10 Seam Workings

The pre-mining drainage plan for the longwall workings scheduled for the No. 10 seam between 2025 and 2029 is illustrated on Figure 4-12. The pre-feasibility study proposes directional drilling in-seam boreholes in the No. 10 seam from the No. 2 seam workings to provide for increased drainage time. This could take place as early as 2021 using the underlying seam to vertical well interception concept presented in Section

3.1.1 (Figure 3-1). Because of the amount of drainage time available, long directionally drilled boreholes can be placed 47 to 57 m apart to achieve the target residual gas content reduction of 30 percent.

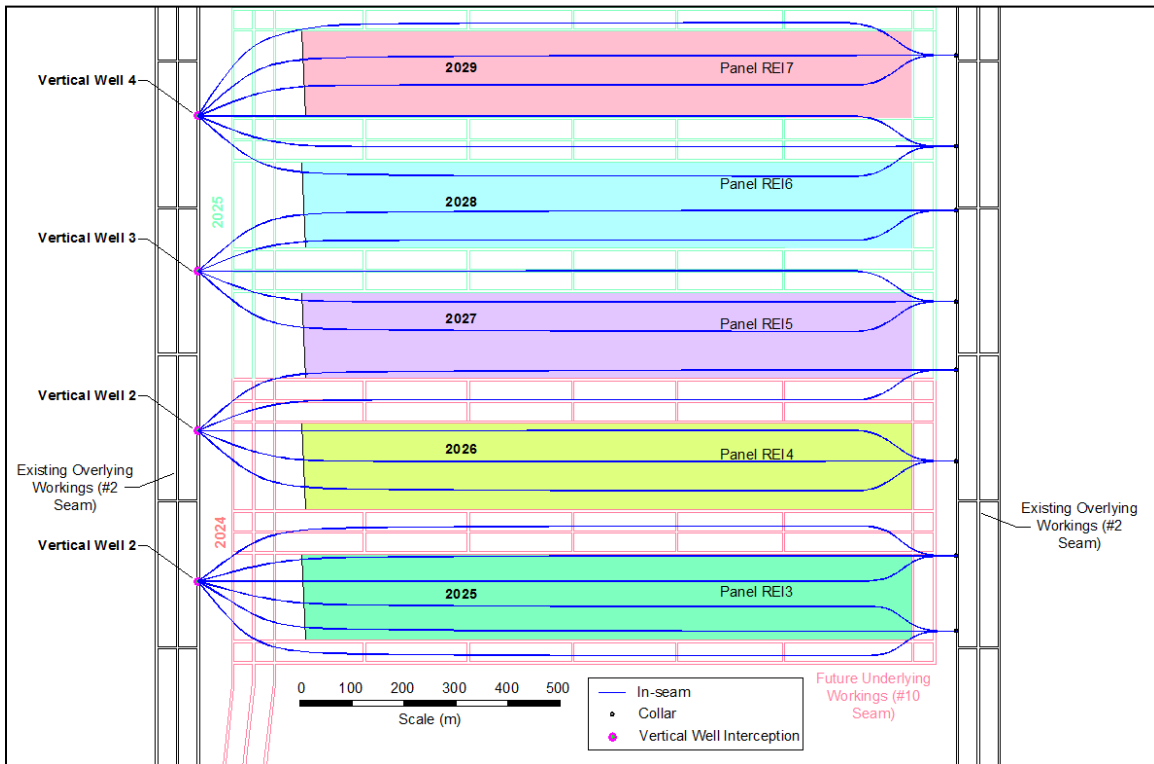

Figure 4-12: Plan view of in-seam methane drainage approach in the No. 10 seam.

The pre-feasibility study assumes that a second longwall district comprised of six additional longwall panels, similar to that shown on Figure 4-12, will be developed in the No. 10 seam and that pre-mining drainage and drilling from the No. 2 seam workings would be feasible, and continue through 2029. The envisioned total in-seam directional drilling requirements for the No. 10 seam through 2029 include 66,000 m of directionally drilled borehole, from 22 borehole collars, and 7 vertical wells with 40 vertical well interceptions. The directional drilling schedule for pre-drainage drilling of the No. 10 seam is shown in Table 4-6.

No. 10 Seam: In-Seam Drilling Requirements		
Year	Area	Annual Drilling (m)
2021	Panel REI3	7,312
	Panel REI4	5,840
	Panel REI5	2,974
2022	Panel REI5	4,427
	Panel REI6	4,423
2023	Panel REI6	2,947
	Panel REI7	5,944
2024	Panel REI8	4,445
2025	Panel REI9	4,445
2026	Panel REI10	4,445
2027	Panel REI11	4,445
2028	Panel REI12	4,445
2029	Panel REI13	4,445

Table 4-6: In-seam directional drilling plan for the proposed No. 10 seam workings.

4.2 Recommended Gob Gas Drainage Approach

A gob degasification approach that implements HGB's drilled from the mining seam to a derived height above the low-pressure side of the longwall panel, near the tailgate entry, is recommended. With this approach, the borehole is maintained along the entire length of the longwall panel, approximately 1,000 m, and can be drilled from the mains. The intent is to place the HGB's above the rubble zone in the fracture zone at an elevation where they remain intact when under-mined. The intent is to also target where the strata will be in tension when under-mined, along the edges of the longwall panels, and not along centerline where re-compaction may occur. The objective is to create a low pressure sink to draw gas generated from overlying gas bearing sources that have been affected by mining induced fractures away from the tailgate return entry as shown on the concept drawing on Figure 4-13.

Installation requires a standpipe of significant competence, centralized and cemented in place, and pressure tested to withstand 1.5 x anticipated shut-in pressures. The HGB may be drilled to larger diameters to increase capacity, left open hole, or lined with perforated steel casing along its length if borehole stability in the fractured rock is a concern.

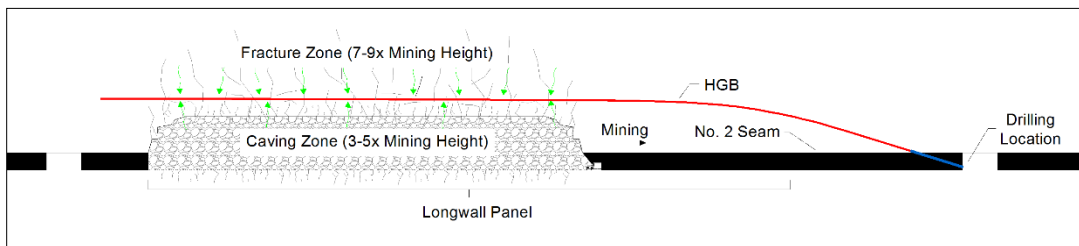

Figure 4-13: Profile view of the HGB drilling approach.

4.2.1 Gob Gas Drainage Plan for the No. 2 Seam Mine Workings

For the pre-feasibility study, the HGB's have been designed for the same methane production capacity of the current cross-measure borehole system. This approach will greatly reduce overall drilling and gas collection infrastructure requirements relative to current practices. Because only a single collar needs to

be managed (vacuum pressure as a function of gas production rate and gob gas quality), gob gas produced from the HGB's will be of much higher quality than with the current practice, and estimated at 60-70 percent methane in air by volume.

4.2.1.1 Gob Gas Flow Rates:

The gob gas flow rate of HGB's as a function of gas composition, borehole diameter, and vacuum pressure have been derived from empirical analyses using measurements from actual field applications, and can be estimated using the equation presented below. This same equation was used to derive Figures 4-14 and 4-15 which are capacity charts for 1,000 m HGB's of varying completion diameters and vacuum pressures assuming a gas quality of 70 percent methane in air mixture by volume.

HGB gob gas flow rate:

$$Q = 1.3303 (10)^{-5} \left(\frac{T_b}{P_b} \right) \left[\frac{(P_1^2 - P_2^2)}{GT_f LZ f} \right]^{0.5} D^{2.5}$$

Where:

Q = gas flow rate, measured at standard conditions, l/s

f = coefficient of friction, dimensionless

P_b = base (standard) pressure, kPa

T_b = base (standard) temperature, K

P_1 = upstream pressure, kPa

P_2 = downstream pressure, kPa

G = gas gravity (air = 1.0)

T_f = average gas flowing temperature, K

L = pipe length, km

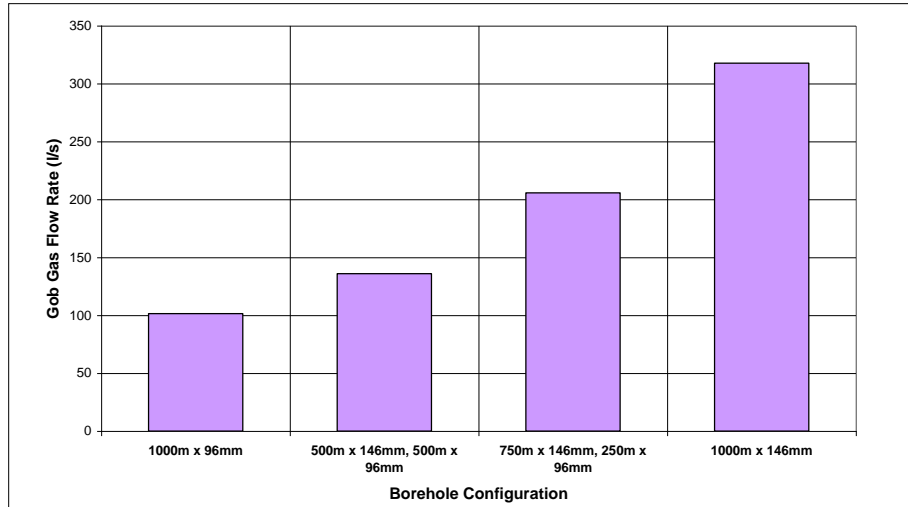

Figure 4-14: Gas flow rate (70 percent methane in air) for 1,000 m HGB configurations with wellhead vacuum of 20 kPa.

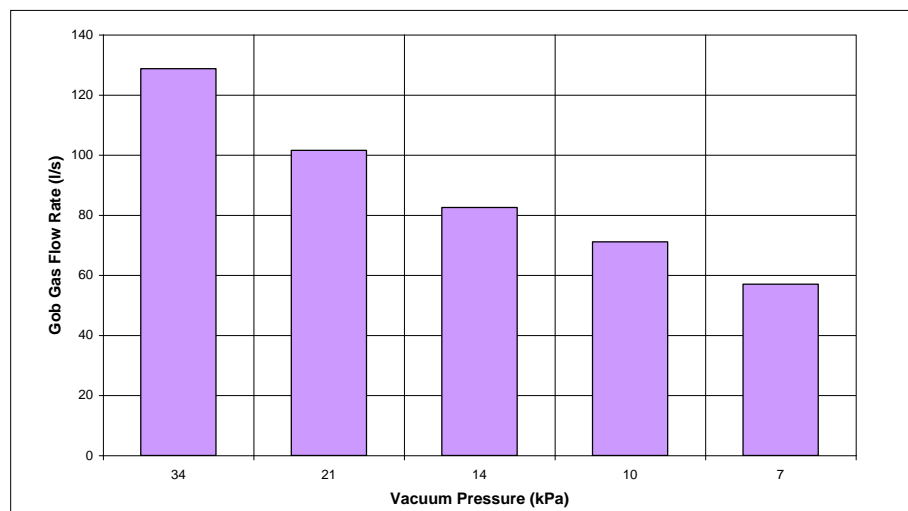

Figure 4-15: Gas flow rate (70 percent methane in air) for a 1,000 m x 96 mm diameter HGB as a function of wellhead vacuum.

4.2.1.2 Implementation for No. 2 Seam Longwalls

Based on historical cross-measure borehole methane production data from Longwall Panel 2-104, the maximum average monthly methane production from nearly 500 cross measure boreholes (high angle and low angle each spaced every 4 m) was 2.5 m³/min. According to Figure 4-14, the estimated gob gas production rate at 70 percent methane in air from a single HGB drilled to 96 mm in diameter and operating at a wellhead vacuum pressure of 20 kPa vacuum, is 100 l/s or 6 m³/min of gob gas or 4.2 m³/min of methane. This is close to twice the maximum average monthly methane flow rate measured for the cross-panel system implemented for Longwall Panel 2-104. This pre-feasibility study assumes that one HGB drilled to a diameter of 96 mm and operated at a wellhead vacuum of 20 kPa will be sufficient to control current gob gas emissions from overlying strata or remnant coal in the gob per for longwall panels in the No. 2 seam as shown on Figure 4-16.

This system may not be as effective at maintaining the gas fringe away from the methane monitoring point located at the intersection of the longwall face and tailgate during longwall cutting and top caving as the current system of cross-measure boreholes, but this could be addressed by modifying longwall ventilation practices as recommended in Section 3.4.4.

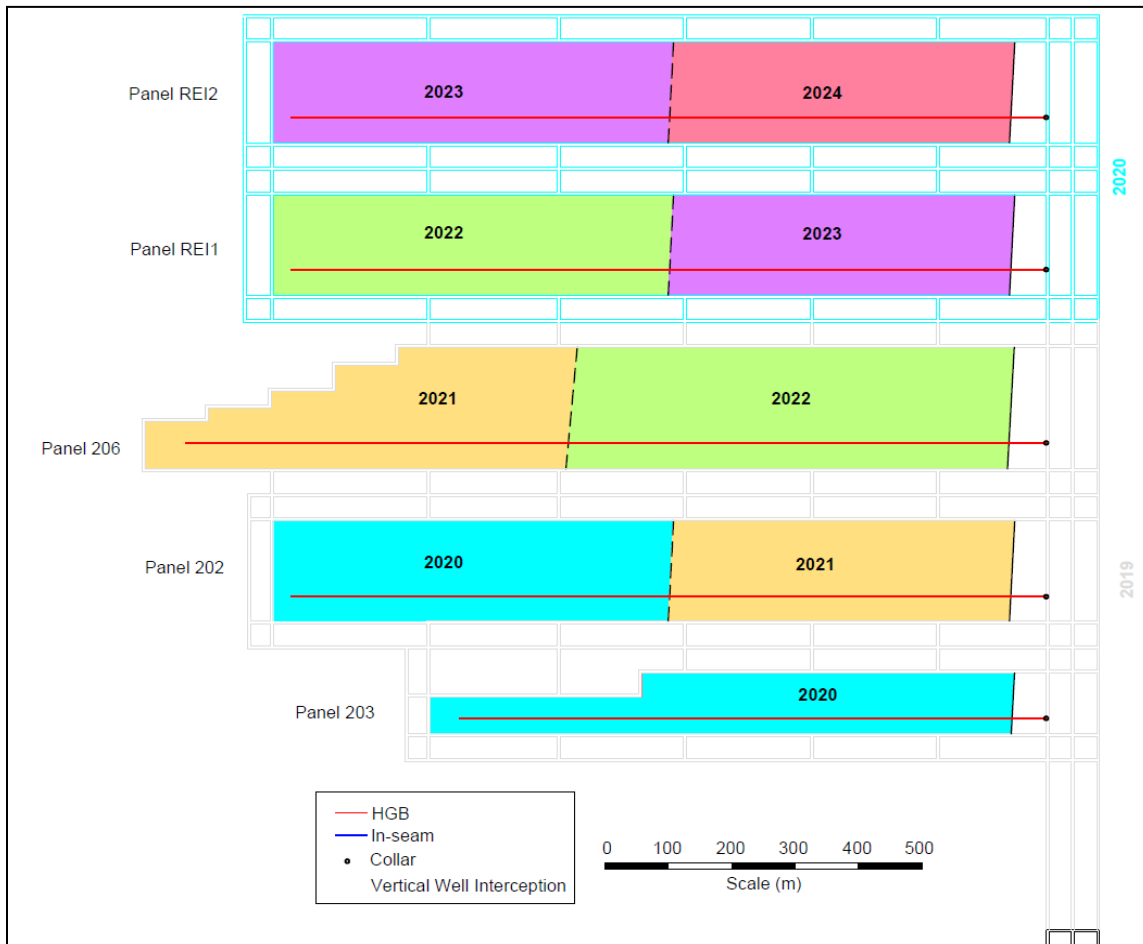

Figure 4-16: Plan view of gob degasification plan in the No. 2 seam.

4.2.2 Gob Gas Drainage Plans for the No. 10 Seam Workings

Based on the current negligible methane recovery rate from gob gas drainage systems implemented for the No. 2 seam longwall panels, and considering that the No. 10 seam extraction height will be 60 percent of the No. 2 seam extraction height, and that the No. 2 seam will most likely be mined out over the No. 10 seam longwall panels, this pre-feasibility study assumes that no gob gas recovery system will be implemented for No. 10 seam longwall panels.

5 Future Methane Drainage Projections

Annual methane gas production forecasts were developed for each year of the 10 year mine plan (2019 – 2029) (“Project Period”).

5.1 Borehole Production Rates

The average number of in-seam boreholes on line and the number of active horizontal gob boreholes on line at each mid-year during the project period were identified. Gas production rates were derived for each in-seam borehole by taking into account the implementation schedule and the borehole spacing, and denoting the corresponding gas production from the methane flow rate prediction curves presented on Figures 4-9 and 4-10 for the No. 2 and No. 10 seams, respectively, and tabulated as shown on Table 5-1. For this per-feasibility study, the methane production from all active horizontal gob boreholes was derived using the 6 m³/min and 70 percent methane concentration production per horizontal gob borehole parameter and added to the in-seam methane production to derive the total estimated annual drainage forecast. This figure was adjusted for 2-105 as it will be using current cross-measure techniques, and Longwall Panel 203 which is half of typical width (60/100 m versus 200 m).

Year	Production Rate (m ³ /day)				Annual Production (million m ³)		
	In-Seam		HGB	Total	In-Seam	HGB	Total
	No. 2	No. 10					
2019	20,665	-	2,160	22,825	7.54	0.79	8.33
2020	17,000	-	2,160	19,160	6.21	0.79	6.99
2021	6,420	10,780	5,760	22,960	6.28	2.10	8.38
2022	2,160	12,630	5,760	20,550	5.40	2.10	7.50
2023	690	15,220	5,760	21,670	5.81	2.10	7.91
2024	-	10,290	5,760	16,050	3.76	2.10	5.86
2025	-	11,160	-	11,160	4.07	-	4.07
2026	-	7,750	-	7,750	2.83	-	2.83
2027	-	10,000	-	10,000	3.65	-	3.65
2028	-	6,640	-	6,640	2.42	-	2.42
2029	-	9,720	-	9,720	3.55	-	3.55

Table 5-1: Gas production rates derived from the methane drainage plan developed for the project period.

5.2 Mine Methane Drainage Production Rates

Figure 5-1 presents the annual methane production forecast from degasification of the mine with the recommended methane drainage improvements presented in Section 3 and 4 over the 10 year period between 2019 and 2029. The forecast predicts recovery of an average of 8 million cubic meters of methane per year between 2019 and 2023. After 2024, when mining moves to the No. 10 seam, the forecast predicts an average production of 3 million m³ of methane per year as degasification focus is on in-seam drainage of the No. 10 seam which is thinner (less gas in place) and lower in gas content, and gob gas recovery is not practiced (or necessary).

The methane production forecast for the early project years, 2019 – 2023 is 20 percent less than current methane production rates of 10 million m³ per year, however, the quality of the gas produced will be significantly higher and will offer the opportunity for gas utilization. The pre-feasibility study does not

consider additional in-seam drilling opportunities or sealed area gas recovery other than those required for safe exploitation of the projected mine plans.

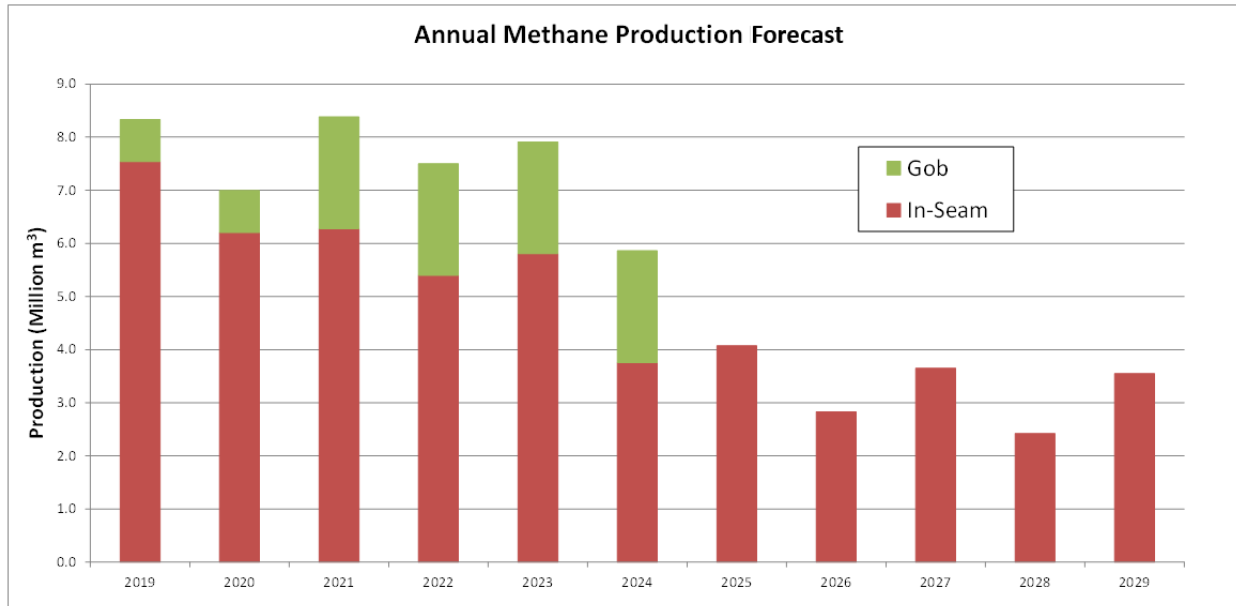

Figure 5-1: Methane production forecast for the proposed methane drainage plan.

5.3 Methane Drainage Drilling Requirements

Table 5-2 summarizes the projected annual directional drilling, vertical well drilling, vertical well interception requirements, and additional gas collection pipeline requirements for the drainage plan proposed for the Project Period. Directional drilling requirements are substantial in the early years of the project as in-seam drainage requires closely spaced boreholes due to the time available for gas drainage based on the mining schedule. Initially this will be a multiple drill effort and time will be of the essence. This pre-feasibility study assumes that the mine will contract an underground directional drilling service with the ability to support the initial phase of the project with multiple drills to perform this work.

Year	In-Seam drilled (m)	HGB drilled (m)	Pipeline Laid (m)	Vertical Well drilled (m)	Vertical Well Interceptions (qty)
2019	47,053	925	1,200	-	0
2020	23,812	1,191	650	-	0
2021	16,125	1,358	800	80	11
2022	8,850	1,191	300	40	5
2023	8,890	1,191	300	40	6
2024	4,445	-	300	-	3
2025	4,445	-	300	40	3
2026	4,445	-	300	-	3
2027	4,445	-	300	40	3
2028	4,445	-	300	-	3
2029	4,445	-	300	40	3
Total	131,400	5,856	5,050	280	40

Table 5-2: Projected annual drilling and requirements for the proposed drilling plan.

Overall, directional drilling through the Project Period will primarily involve in-seam drilling, and development of 138,000 m of borehole, most of which is in-seam. This is roughly equal to the drilling requirements for one single year using current practices on a per-meter basis. Although significantly more expensive than rotary drilling, the future methane drainage plan reduces the total volume of borehole required on a per meter basis by 90 percent.

With the future methane drainage plan and recommendations, additional underground pipeline requirements (pipe and connections) are estimated at 5,000 m which is readily managed for performance and monitored for water accumulation and integrity. Should the mine continue with current practices, the amount of additional underground pipeline required through the Project Period would be 7 times higher, with countless potential points for air intrusion at borehole collars, wellhead connections, and pipe connections, an unmanageable system for performance.

Table 5-3 provides the estimated amount of pipeline required to implement current practices through the Project Period by year. Note that with current practices pipelines are extended along gate roads, typically twin pipelines, while for the recommended methane drainage plan, boreholes are directionally drilled from main entries and pipelines are limited to the main return entries.

Year	Low Vac Pipeline Laid (m)	High Vac Pipeline Laid (m)
2019	1,200	1,250
2020	1,470	1,470
2021	1,540	1,540
2022	1,470	1,470
2023	1,470	1,470
2024	1,470	1,470
2025	1,470	1,470
2026	1,470	1,470
2027	1,470	1,470
2028	1,470	1,470
2029	1,470	1,470
Total	15,970	16,020

Table 5-3: Projected annual pipeline requirements should the mine proceed with current methane drainage practices through the Project Period.

6 Market Information

CMM in China has evolved from a safety concern to a valued commodity and significant source of natural gas supply (USEPA, 2015). In 2011, the Chinese government's "Natural Gas Development Plan during the 12th Five-Year Plan Period" included CBM/CMM for the first time. This plan, which covered the years between 2011 and 2015, targeted the consumption of 20 Bcm of CBM/CMM by 2015 (USEPA, 2015). Furthermore, the "12th Five-year Plan for CBM and CMM", which was more ambitious, called for total production to rise to 8.4 Bcm, and construction of 13 pipelines with a total length of 2,000 km and 12 Bcm per year of total transport capacity (USEPA, 2015). The "12th Five-Year Plan for CBM and CMM" further targeted CMM to be primarily used for local power generation, called for an increase in the number of household users to 3.3 million and for CMM generating capacity to quadruple to 2,850 MW between 2010 and 2015 (USEPA, 2015). The "13th Five-Year Plan for the Development and Utilization of CBM and CMM" aims to increase CBM/CMM drainage volume up to 24 Bcm and the installed capacity of CMM power generation units up to 2.8 million kW. The new plan highlights utilization of abandoned coal mine methane (AMM) resources in addition to new drainage and power capacity goals (CCII, 2017)

Although CMM drainage and utilization is being heavily promoted by the Chinese government, there are still significant barriers to project development. China's natural gas market and infrastructure are underdeveloped considering that natural gas only accounts for approximately 6.6 percent of China's primary energy consumption (BP, 2018). Most Chinese cities and towns do not offer access to natural gas for the majority of their citizens. The locations of coal mines that produce CMM are mostly in remote mountainous areas with no access to natural gas distribution networks. Constructing pipelines in these remote areas is difficult because of the steep terrain.

From 2006 to 2011, 26 separate CMM power stations with a total power capacity of 381 MW reached interconnection and off-take agreements with the Shanxi Power Grid Company. However, today mining companies are often viewing CMM power projects as a source of electricity supply for the mine, freeing up grid-based power for other end users.

6.1 Shanxi Province Economic Conditions

Shanxi is endowed with abundant energy resources relative to other provinces in China and has seen strong growth in recent years. The province's GDP per capita stood at RMB 35,303 (\$5,140) alongside 4.5 percent growth in provincial GDP in 2016 (HKTDC, 2018). Other major economic indicators have improved in recent years, such as:

- Retail sales of RMB 648.1 billion (\$94.35 billion), representing a 7.4 percent increase in year-over-year growth in 2016.
- RMB 68.7 billion (\$9.9 billion) in exports in 2016, which is an annual increase of 17.9 percent.
- Exports of high-tech products grew by 68.3 percent in 2016 to RMB 41.6 billion (\$6.06 billion).
- Total share of the services sector in GDP went up from 35 percent in 2011 to 55.7 percent in 2016 and the province generated revenue of RMB 422.8 billion (\$61.55) from tourism in 2016, an annual increase of 23.3 percent.

Shanxi aims to cut its coal production by 258 million tons by 2020 in accordance with China's 13th Five-Year Plan (2016-2020), which promotes cleaner sources of energy. While coal still plays a large role in the province's economy, it's total share of GDP is dropping as investments in emerging industries accounted for 53.1 percent of the total investment in 2015, up almost 20 percent compared to 2011 (China Daily,

2018). CBM and CMM capture and use projects like the one considered at the TengHui Coal Mine would help provide a supply source for the increasing demand for cleaner forms of energy.

6.2 Energy Commodity Markets in Shanxi Province

6.2.1 Power

At the end of 2017, the province's power generation installed capacity was 80.7 million kW, an increase of 5.7 percent from the end of 2016. Making up part of total installed capacity was thermal power's installed capacity of 63.7 million kW, an increase of 0.6 percent; installed capacity of grid-connected wind power of 8.7 million kW, an increase of 13.1 percent; and installed capacity of grid-connected solar power generation, which rose 98.9 percent from the previous year to 5.9 million kW. Secondary industry (manufacturing and construction) consumed 78.7 percent, or 156.87 billion kWh of the province's electricity in 2017. Overall investment increased in the industrial sector by 3.1 percent, but investments in coal industry declined by 8.6 percent in 2017 (NSBSSC, 2018).

Provincial governments are vigorously promoting development of local renewable energy, but conditions are estimated to only allow for small-scale distributed wind and biomass power plants. As a result, the different forms of energy transmission between provinces with energy surpluses and deficits will become an increasingly important feature of electricity economics in the central grid region (USEPA, 2015a).

6.2.2 Other Relevant Energy Markets

The government's draft 12th Five-year Plan for natural gas explicitly included CBM for the first time and Shanxi province is spearheading a relatively aggressive in-province mixed natural gas-CBM pipeline program that includes, among other facilities:

- 2 Bcm/yr, 460 km line from Changzhi to Taiyuan, completed in 2012, with a mixture of Qinshui CBM and conventional gas shipped from Sinopec's Shaanxi-Shandong line.
- Two pipelines totaling over 300 km with capacity to ship about 1 Bcm from Ordos and Gujiao areas to Taiyuan.
- A 471 km line from the Linxian area of the Ordos CBM basin south to Linhe completed in 2012, which will be extended to the northwest to accept gas from the third Shaanxi-Beijing pipeline.
- A 1 Bcm/yr, 50 km transprovincial pipeline from Qinshui to Bo'ai in Henan Province, completed in late 2010.

According to the Shanxi Provincial Coalbed Methane Exploitation Plan, Shanxi plans to reach 20 Bcm of coalbed gas extraction volume by the end of 2020 and build more than 10,000 km of pipelines to bring gas to 70 percent of the province. The State-owned Assets Supervision and Administration Commission (SASAC) of the province made recent plans to reorganize Shanxi Gas Group to become the first provincial-level natural gas company in China that integrates gas exploration, development, pipeline and gas terminal through ways like asset transfer, equity transfer and equity cooperation of numerous companies involved with energy, transportation and CBM.

To date, Shanxi Province gas companies have not been able to achieve interconnection due to competition, which has resulted in higher pipeline transportation costs and lower operating efficiencies. The establishment of a provincial-level natural gas company is expected to help facilitate the integration of Shanxi's natural resources while using cleaner forms of energy (XFA, 2017).

6.3 Environmental Markets

Since 2005, China has participated in the global carbon market through the Clean Development Mechanism (CDM) under the United Nations Framework Convention on Climate Change (UNFCCC). From 2005 through 2012, the National Development and Reform Commission (NDRC) approved 128 CMM projects under the CDM, although not all projects qualified for Certified Emission Reductions (CERs) during the eligibility period, which ran from 2008 through 2012. Since 2012, the price of CERs has dropped to RMB 1.79 (\$0.26) from its initial opening price of RMB 139 (\$20) due to a lack of demand, and the CDM is no longer applicable to new CMM projects in China (ICE, 2018). However, by 2013 China established seven pilot carbon markets and launched a national emissions market in late 2017, which currently only covers the power generation industry. The seven carbon emission trading pilots were set up in Shenzhen, Beijing, Guangdong, Shanghai, Tianjin, Hubei, and Chongqing, and in 2016, an eighth carbon exchange was added in Sichuan.

In the future, a Chinese national emissions trading system (ETS) could be the largest market for carbon emissions permits in the world. Originally envisioned to include many major industrial sectors, the national trading system is now expected to cover only the power generation industry (EDF, 2017). Chinese CER credits generated from CMM projects are expected to be eligible for use as offsets in the national market as they have been in some of the pilot carbon markets. However, the percentage of allocations that can be met with CERs is currently unknown. The carbon emissions covered by the carbon market as a percentage of total carbon emissions is roughly 30 percent, representing 3,500 million tons of CO₂e.

Voluntary carbon markets remain an option for Chinese CMM projects. There is a global market for voluntary emission offsets from CMM and other offset project types. The market is generally driven by corporate social responsibility or other actions intended to reduce an entity's environmental footprint. Voluntary market transactions are often "over the counter" meaning that they are conducted directly between a buyer and seller and the prices and volumes transacted are rarely publicized. Discussions with persons active in these markets indicate that prices can range up to RMB 27.86 – 34.82 (\$4.00 - 5.00) per tCO₂e; however, these prices cannot be confirmed, and it is assumed that prices this high are rarely achieved.

Another potential option for environmental markets is the International Civil Aviation Organization (ICAO). In October 2016, ICAO passed an Assembly Resolution for carbon neutral growth starting in 2020. As of September 2018, 66 states accounting for over 86 percent of international airline emissions have joined the voluntary phase of this program beginning in 2020. ICAO is currently developing rules for offsets and approved offset programs for its Carbon Offsetting and Reduction Scheme for International Aviation (CORSIA). Under CORSIA, ICAO members will be seeking to reduce 2.5 billion tCO₂ equivalent emissions through 2035 resulting in an annual offset demand of 142 to 174 MtCO₂e to 2025 and 443-596 MtCO₂e to 2035 (Ripley, 2018). This market may present significant opportunities for international CMM emission offset projects.

Although there are potential offset markets for CMM emission reductions and it is conceivable that a CMM project could realize some additional revenue from selling emission offsets, this analysis assumes that there is no market for emission offsets in the base case. It is very difficult to justify providing a value given the low CER price, the lack of transparency in pricing for voluntary emission reductions and the uncertainties around ICAO's CORSIA program.

6.4 Legal and Regulatory Environment

As part of China's broader strategy to reduce air pollution, the government set a target of 40 Bcm of CBM/CMM production by 2020, which is more than double the country's 2015 production of 18 Bcm. To incentivize companies to invest in the CBM/CMM industry, China has offered gas producers preferential policies, including exemption from equipment import duties, refunds on value-added tax collected from gas sales, accelerated depreciation of assets, tax credits for investment in technical innovation, free-gas market pricing, and access to technology development funds (Econotimes, 2016).

CMM power stations in Shanxi Province totaled more off-take and interconnection agreements with the Shanxi Power Grid Company than agreements made in any other province.

- The grid currently pays an off-take price of RMB 0.30/kWh (\$0.043/kWh) as a national subsidy related to CBM/CMM production.
- The governmental subsidies for CMM exploitation and development during the 13th Five Year Plan provide Shanxi Province additional funding of 0.1 RMB/m³ (\$0.015/m³) (GMI, 2016).

While numerous beneficial policies exist to promote the development of the CBM/CMM industry in China, it is not clear how effective these incentives will be as the sector faces numerous hurdles to development.

6.5 CMM Utilization Options for the TengHui Mine

Implementation of the proposed gas drainage plan will considerably increase the quality of CMM produced at TengHui. Although the quantity of gas produced will not change appreciably from the quantity of gas available today, CH₄ concentrations are expected to increase to 65 percent in the gob gas drainage system and 85 percent in the in-seam drainage system. The increase in gas quality presents the opportunity for utilization of CMM not available to the mine today. The sections below briefly explore each potential option for CMM utilization at TengHui Mine.

6.5.1 Power Generation

On-site power generation using CMM is one of the utilization options considered in this study. Electricity generated by a CMM power plant would be used at the mine. Due to the size of the plant, it is unlikely to produce excess power that would be sold to the local electric grid. There is a strong case to use the CMM for power generation because of the significant experience at SCCG and throughout the Chinese coalfields with CMM power projects. The knowledge, expertise, and experience are widely available to support cost-effective implementation, operation, and maintenance of a CMM power plant. Industrial power prices are also attractive for CMM to-power projects. A generally accepted breakeven cost for CMM-based power projects is RMB 0.27 to 0.40/kWh (\$0.039 to 0.058/kWh). The price paid by the TengHui Mine is RMB 0.65/kWh (\$0.094/kWh). In addition, the RMB 0.40/m³ (\$59,717/Mm³) subsidy, available through a combination national and provincial support, makes power generation even more attractive in Shanxi (GMI, 2015).

Power generation is also the favored use of TengHui Mine management who have indicated that they plan to move forward with a CMM power project if it proves to be feasible.

6.5.2 Town Gas/Natural Gas

Historically, town gas was the predominant use of CMM in China prior to the Kyoto Protocol, when power generation grew in popularity. Town gas is produced from in-mine or surface gob wells. Town gas is

medium-quality, usually ranging from 30 to 60 percent CH₄, and is distributed to local communities in the immediate vicinity of a coal mine through low pressure distribution lines. In contrast, natural gas pipelines typically require very high-quality gas, normally above 90 percent CH₄, with strict specifications for other constituents including moisture content, CO₂, H₂S, etc.

Neither option is available for the Tenghui Mine. The physical location of the mine in a mountainous area without access to pipelines means that construction of a town gas delivery system would be prohibitively expensive. Moreover, it would require conversion of coal-based heating and cooking systems to create a market for the gas. Likewise, natural gas transmission is also not a realistic option because a transmission pipeline is not accessible nor is the gas quality likely to meet the pipeline specifications.

6.5.3 Industrial Use

There are no industrial options for use of CMM near the mine other than possibly using CMM to fuel a coal preparation plant. However, TengHui Mine management did not express interest in this option.

6.5.4 Boiler Fuel

Coal boilers are used at many mines for heating and hot water in mine buildings and for heating mine shafts. It has become a priority for the Chinese government to replace coal-fired boilers with natural gas boilers or boilers using other cleaner burning fuels. CMM could be used at the TengHui Coal Mine to fuel boilers used for heating and hot water in the mine buildings and employee apartments. There is also demand for heating during the winter. Using CMM in boilers in place of coal would necessarily require upgrading the gas quality to at least medium concentration gas. Due to the cost of gas processing equipment, this is not likely to be economically feasible. Compared with CMM power, this is also a lower priority for TengHui management.

6.5.5 Compressed Natural Gas (CNG)/Liquefied Natural Gas (LNG)

There is growing interest in CNG and LNG in China as demonstrated by the USEPA feasibility study for the Songzao Mine in Chongqing (U.S. Environmental Protection Agency, 2009). Certainly, the continuing development of natural gas infrastructure in Shanxi province, including CNG and LNG operations, provides a potential avenue for a CMM-to-CNG/LNG operation. However, CNG or LNG is not economically feasible at this time, even if future gas production is medium quality. CNG and LNG production requires significant capital costs to upgrade gas quality, compress, and liquefy the gas. For example, capital expenditures to manage the residual gas flow at each mine could total RMB 20.61 million (\$3 million) for CNG and RMB 41.21-48.06 million (\$6-7 million) for an LNG plant. Operating expenses at each mine could total RMB 6.87-13.74 million (\$1-2 million) per year. The sale price for LNG would need to be roughly RMB 2.15 per 1,000 metric tons or the equivalent of RMB 3.0/m³ (\$12.00/Mcf) of pipeline quality gas.

6.5.6 Flaring

To be allowed in China, flaring must be part of an integrated approach that includes other CMM utilization options such as power generation, industrial supply, boiler fuel or CNG/LNG production. A good strategy may be to incorporate a flare into the project to reduce emissions when the primary utilization technology is unavailable, for example when gas engines are down for maintenance. Without a price for carbon emission reductions, however, installing and operating a flare may not be an economically feasible component of a power project in this case.

6.6 Recommendation for CMM Utilization

After consideration of the potential options for CMM utilization at the TengHui Mine, power generation is the most viable option, considering current market conditions in Shanxi Province and the priorities of mine management. Therefore, for this pre-feasibility study, the Economic Analysis in Section 7 focuses on CMM power generation. Based on gas supply forecasts, the mine could be capable of operating as much as 5.2 MW of electricity capacity.

7 Economic Analysis

7.1 Project Development Overview

In order to assess the economic viability of the drainage scenarios presented throughout this report, it is necessary to first define the project scope. CMM gas production profiles generated a single project development case, which involves a combination of in-seam and gob gas drainage.

7.2 Project Economics

7.2.1 Economic Assessment Methodology

The economic and financial performance of a proposed TengHui Mine CMM drainage and utilization project were evaluated using key inputs discussed in the following sections of this report. A discounted cash flow model of CMM drainage and power sales was constructed to evaluate project economics. Key performance measures that were used for evaluating the project included net present value (NPV), internal rate of return (IRR), and payback period (years). The results of the analyses are presented on a pre-tax basis.

7.2.2 Economic Assumptions

Cost estimates for goods and services required for the development of the CMM project at the TengHui Mine were based on a combination of data provided by the TengHui Mine, known average costs based on analogous projects in the region, and publicly available sources. The pre-feasibility study uses conservative assumptions. A more detailed analysis should be conducted if this project advances to the full-scale feasibility study level. The major cost components for the CMM project include the directional in-seam and gob drilling costs, generation cost factor, gathering line and power plant.

7.2.2.1 Drainage System Input Parameters

The drainage system capital cost assumptions, operating cost assumptions, and physical and financial factors used in the financial analysis are provided in Table 7-1. A more detailed discussion of each input parameter is provided below.

Physical and Financial Factors	Units	Value
Price Escalation	percent	3%
Cost Escalation	percent	3%
Capital Expenditures	Units	Value
Drainage System		
In-Seam Drilling Costs – directional Proposed drainage program	\$/m	100
Gob Drilling Costs – directional Proposed drainage program	\$/m	130
In-Seam Drilling Costs - cross-panel Current TengHui drainage program	\$/m	30
Gob Drilling Costs - cross measured Current TengHui drainage program	\$/m	39
Gathering & Delivery System		
Gathering Pipe Cost	\$/m	75
Compressor Efficiency	hp/m ³	1
Contingency Fee	percent	0%
Operating Expenses	Units	Value
Field Fuel Use (gas)	percent	10%
Water Treatment and Disposal	\$/bbl	0.5

Table 7-1: Summary of Drainage System Input Parameters.

7.2.2.1.1 Drainage System Physical and Financial Factors

Price and Cost Escalation: All prices and costs are assumed to increase by 3 percent per annum.

7.2.2.1.2 Drainage System Capital Expenditures

The drainage system includes the in-seam and directional gob drainage boreholes. Normally it would also include the cost of installing vacuum pumps used to bring the drainage gas to the surface. However, a pump station was recently installed at the TengHui Mine, and it is sufficient to continue service under the proposed gas drainage program.

The major input parameters and assumptions associated with the drainage system are as follows:

Borehole Cost: In-seam borehole costs are estimated at \$100/m. HGB costs are estimated at \$130/m. In comparison, current marginal borehole costs (\$/m) at the TengHui Mine are 30 percent of the proposed marginal costs.

Gathering System Cost: The gathering system consists of the piping and associated valves and meters necessary to get the gas from within the mine to the power plant located on the surface. The gathering system cost is a function of the piping length and cost per meter. For the proposed project, we assume a piping cost of \$75/m and roughly 5,050 m of pipeline laid from 2019-2029 for the proposed system. In contrast, we assume 31,990 m of pipeline will be laid for the existing drainage program at TengHui.

Contingency Fee: No fee added for unforeseen technical or regulatory difficulties with drainage plan.

7.2.2.1.3 Drainage System Operating Expenses

Field Fuel Use: For the proposed project, it is assumed that CMM is used to power the vacuum pumps and compressors in the gathering and delivery systems. Total fuel use is assumed to be 10 percent, which is deducted from the gas delivered to the end use.

Water Treatment and Disposal: The costs associated with water treatment and disposal is \$0.5/bbl.

7.2.2.2 Power Plant Input Parameters

The drained methane can be used to fuel internal combustion engines that drive generators to make electricity for use at the mine or for sale to the local power grid. The major cost components for the power project are the cost of the engine and generator, costs for gas processing to remove solids and water, and the cost of equipment for connecting to the power grid. The assumptions used to assess the economic viability of the power project are presented in Table 7-2. A more detailed discussion of each input parameter is provided below.

Physical and Financial Factors	Units	Value
Price Escalation	percent	3%
Cost Escalation	percent	3%
Baseline Electricity Generation Capacity	MW	3.71
Power Sales Price	\$/kWh	0.094
	RMB/kWh	0.65
Generator Efficiency	percent	35%
Run Time	percent	60%
Generator Delay	Years	1.5
CMM Subsidy	\$/Mm ³	59,717
	RMB/m ³	0.40
Capital Expenditures	Units	Value
Generation Cost Factor	\$/kW	800
Generator Relocation Fee	\$/kW	0
Development Fee	percent	20%
Contingency Fee	percent	10%
Operating Expenses	Units	Value
Power Plant O&M	\$/kWh	0.03
Contingency Fee	percent	10%
Carbon Emission Reduction	Units	Value
Global Warming Potential of CH ₄	tCO ₂ e	25
CO ₂ from Combustion of 1 ton CH ₄	tCO ₂	2.75

Table 7-2: Summary of Power Plant Input Parameters.

7.2.2.2.1 Power Plant Physical and Financial Factors

Price and Cost Escalation: All prices and costs are assumed to increase by 3 percent per annum.

Baseline Electricity Capacity: The minimum electricity generation capacity was used to determine the baseline electricity capacity of 3.71 MW. There is no flaring involved during generation because the base case assumes there is no real carbon market.

Generator Efficiency and Run Time: Typical electrical power efficiency is between 30 percent and 44 percent and run time generally ranges between 5,000 to 8,300 hours annually depending on the manufacturer. Chinese-made gas engines generally operate at the lower end of this range, and it is assumed that Chinese-made engines will be used. For the proposed power project an electrical efficiency of 35 percent and an annual run time of 60 percent, or 5,256 hours, were assumed. The efficiency value is based on information provided by the China Coal Information Institute (CCII) and the run time value is consistent with the typical operation of engines in the field.

Electricity Price and CMM Subsidy: The effective electricity sales price received for the power produced is RMB 0.65/kWh (\$0.094/kWh) along with a CMM subsidy of RMB 0.40/m³ (\$59,717/Mm³).

Generator Delay: Delayed power plant start-up of 18 months after start of the directional drilling program.

Emissions Reductions Benefits/CMM Subsidy: Although a price for CMM emissions offsets may be possible, this study takes the conservative assumption that there is no value for such offsets. As previously noted, there is no consistent and transparent value for carbon emission reductions for CMM projects in China.

7.2.2.2.2 Power Plant Capital Expenditures

Generation Cost Factor: This value, assumed to be \$800/kW, is a fully loaded cost. It is assumed to include the capital cost for the containerized gas generator set (gas engine and generator), civils, gas pretreatment including dust and moisture removal, electrical interconnection, spare parts, warranty and delivery, installation, commissioning and start-up.

Generator Relocation Fee: Relocation fee is \$0/kWh because this project involves no relocation.

Development Fee: A fee is included to account for the cost of project development including staff costs, equipment, office space, transportation and other resources necessary to plan and develop the project. The fee is estimated at 20 percent of the cost of the power plant based on experience in the field.

CAPEX Contingency Fee: A 10 percent contingency fee is added for unforeseen additional costs.

7.2.2.2.3 Power Plant Operating Expenses

Power Plant Operating and Maintenance Cost: The operating and maintenance costs for the power plant are assumed to be \$0.03/kWh.

OPEX Contingency Fee: A 10 percent contingency fee is added for unforeseen additional costs.

7.2.2.2.4 Carbon Emission Reductions

Global Warming Potential of CH₄: A global warming potential of 25 is used. This value is from the Intergovernmental Panel on Climate Change Fourth Assessment Report (IPCC, 2013).

CO₂ from Combustion of CH₄: Combustion of methane generates CO₂. Estimating emission reductions from CMM projects must account for the release of CO₂ from combustion when calculating net CO₂ emission reductions. For each ton of CH₄ combusted, 2.75 tCO₂ is emitted, resulting in a net emission reduction of 18.25 tCO₂e per ton of CH₄ destroyed.

7.2.3 Economic Results

The economic results for the power plant project are summarized in Table 7-4. TengHui Mine management requested a power plant-only scenario because the gas drainage program's costs will be absorbed by the mining operation as operational costs. The power plant returns were achieved by zeroing out the cash flows for the gas drainage program to represent the mining operation's cost absorption. Higher NPV and IRR values are present in the power plant only scenario because of this cost absorption. Higher IRR and NPV values are also attributable to a low generation cost factor of RMB 5,567/kW (\$800/kW) and electricity sales price received for the power produced of RMB 0.65/kWh (\$0.094/kWh) along with a CMM subsidy of RMB 0.40/m³ (\$59,717/Mm³). It is also important to note that in the power plant only scenario, the cost of gas purchased is not included. It is assumed that the mining operation will provide the CMM for free to the power plant. If there is a cost of gas purchased, it would be expected to reduce the IRR and NPV for the project in the base, high and low cases.

The results for the entire project, including gas drainage and the power project, are presented with inputs set to their high, base and low case outcomes in Table 7-5. The gas drainage program involves in-seam drilling, HGB drilling and vertical well interceptions, which all add to costs of the project and decrease returns. Max power plant capacity and net CO₂e reductions are the same for both projects because those values are largely reliant on the quantity of gas production, which used the same high, base and low case values for the different project scenarios. The high, base and low cases were determined in terms of NPV and IRR through different scenarios of key input variables, of which are detailed in Tables 7-1, 7-2 and 7-3. The discount rate used for all NPV calculations in the results tables is 10 percent.

Case	Low	Base	High
Power Sales Price (\$/kWh)	-10%	.094	+10%
Power Plant Delay (Years)	2 years	1.5 years	1 year
Power Plant CAPEX (\$,000s)	25%	20%	15%
Power Plant OPEX (\$,000s)	+10%	0.03	-10%
Emission Reductions Benefits (\$/tCO ₂ e)	0.0	0.0	1.0
Gas Production (Mm ³)	-30%	86.2	+30%
Operating Efficiency	30%	35%	40%
Run Time	55%	60%	65%

Table 7-3: High, base and low case sensitivities used for key inputs of the financial analysis.

Case	Max Power Plant Capacity	NPV (\$,000s)	IRR	Payback (Years)	Net CO ₂ e Reductions (t CO ₂ e)
High	5.23 MW	\$11,045	43.57%	2.3	1,481,616
Base	3.71 MW	\$2,966	19.97%	4.5	1,139,704
Low	3.47 MW	\$69	10.30%	6.3	797,793

Table 7-4: Power Plant (only) IRR scenarios (pre-tax).

Case	Max Power Plant Capacity	NPV (\$,000s)	IRR	Payback (Years)	Net CO ₂ e Reductions (t CO ₂ e)
High	5.23 MW	\$9,491	22.06%	4.9	1,481,616
Base	3.71 MW	\$1,684	12.23%	6.45	1,139,704
Low	3.47 MW	\$(943)	8.72%	7.24	797,793

Table 7-5: Summary of Economic Results for power plant and gas drainage programs (pre-tax).

When looking at the returns for the entire project, i.e., gas drainage plus the power plant, a major contributing factor for the positive returns are the cost savings through the proposed gas drainage improvements employing directional drilling, even though the marginal cost of drilling the horizontal boreholes is higher. This is due to the following:

- Fewer boreholes are drilled and there is a significant reduction in total borehole length in the proposed plan. The new plan calls for a significantly reduced number of boreholes and total length as shown in Table 5-2. On a 1,200 m panel, the existing plan calls for one 165 m in-seam borehole, one 83 m high level cross-measure borehole, and one 38 m low level cross-measure borehole drilled every 4 m. This results in approximately 86,000 m of borehole drilled in every 1,200 m panel. In comparison, when boreholes are drilled along the length of the panel, fewer boreholes are required. The proposed drainage plan estimates that only 142,000 m will be drilled in the mine through 2029, a substantial reduction from the estimate 938,000 m required using the existing TengHui approach.
- Significantly less pipeline will be laid in the proposed approach. The existing approach uses 31,990 m of pipeline and the new approach uses only 5,050 m, as shown in Tables 5-2 and 5-3. The existing approach used by the TengHui Mine requires laying high and low pressure gathering lines the full length of each panel and then in the main entries. Under the proposed plan, the gathering line is only required in the main entries.
- Only in-seam boreholes are drilled in the No. 10 seams. HGB's are not necessary.

The pre-feasibility study report summarizes the cost savings on a discounted cash flow basis to quantify the positive economic impact of the proposed drilling approach in Table 7-6. The directionally drilling program results in cost savings of nearly \$11 million over 10 years compared to the current TengHui program that employs cross-panel and cross-measure boreholes in both the No. 2 seam and will employ in the No. 10 seam. If the TengHui Mine were to modify its current drainage program but remove cross-

measure boreholes in the No. 10 seam, then the changing to directional drilling will still produce \$5.4 million in cost savings.

Existing Case	Proposed Plan's NPV of Cost Savings (\$,000s)
Cross-measure boreholes not drilled in the No. 10 seam	5,442
Cross-measure boreholes drilled in the No. 10 seam	10,943

Table 7-6: Cost savings attributable to improved gas drainage using directional drilling.

Additional figures illustrate cost savings (Figures 7-1, 7-2). Project costs for the proposed plan in Figure 7-1 are higher in 2019, but overall create cost savings opportunities when considered over the entire project period (2019-2029). In the later years of the project, potential cost savings increase notably compared to the initial years of the project.

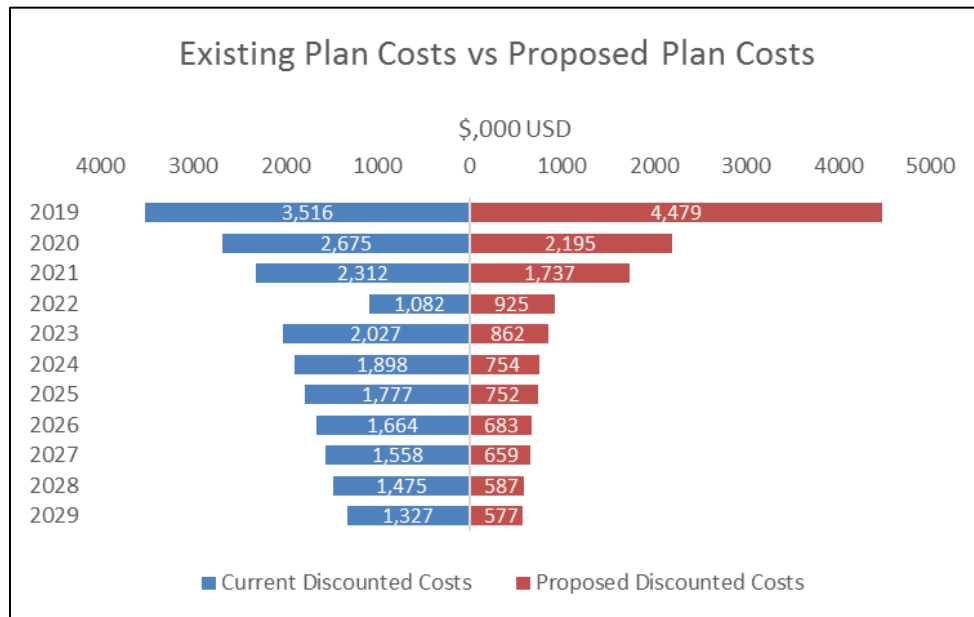

Figure 7-1: Proposed plan costs compared to existing plan costs (both discounted).

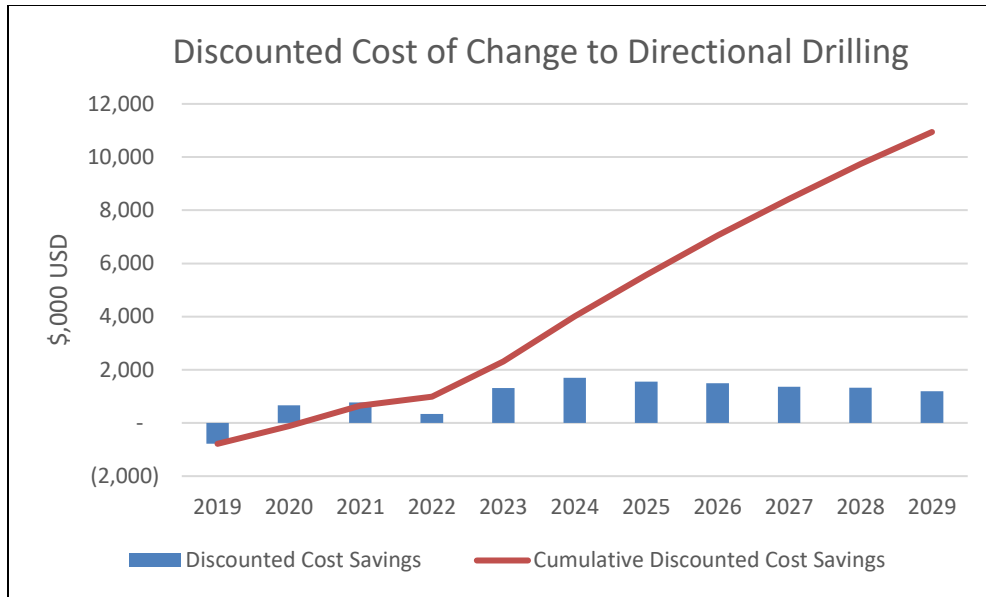

Figure 7-2: Depiction of discounted cost savings over time; cumulative and annual.

7.2.4 Greenhouse Gas Emission Reductions and Energy Generation

Figures 7-3 and 7-4 show the annual and cumulative GHG emission reductions and the annual and cumulative generation output in MWh, respectively, for the base case. Emission reductions are calculated on a yearly basis and are closely tied to yearly gas production and the global warming potential of CH₄. Compared to CO₂, CH₄ has a shorter atmospheric lifetime, but is much more effective at trapping radiation, which makes the impact of CH₄ 25 times greater than CO₂ over a 100-year period (IPCC 2007). Higher predicted gas production also leads to higher emission reduction figures because the gas is used for power production rather than being released directly into the atmosphere. Figures 7-3 and 7-4 both show a steady growth over time as emission reductions and generation output projections are both strongly controlled by predicted annual gas production. Full power and emission reductions potential are not reached until 2021 due to an 18-month delay of generator production at the initial stages of the project.

In Figure 7-3, from 2021-2029 the average emission reductions of the project are 121,434 t CO₂e per year. The cumulative emission reductions depict the total reductions potential over the life of the project, which reaches 1,139,704 t CO₂e in the year 2029 in the base case scenario. Total projected emission reductions for the first two years of the project toad up to 46,799 t CO₂e, which is relatively lower due to the 18-month generator start-delay factor. In Figure 7-4, from 2021-2029 the average generation output reaches 19,479 Mwh per year. The cumulative generation output shows total output over the life of the project and reaches 185,051 Mwh in 2029 in the base case scenario. Projected generation output reaches a total sum of 9,740 Mwh in the first two years of the project, which is relatively lower due to the 18-month generator start-delay. The project could lead to net emission reductions of 1,481,616 t CO₂e and total output generation of 211,487 MWh in an optimal development scenario over the project’s 11-year operating period.

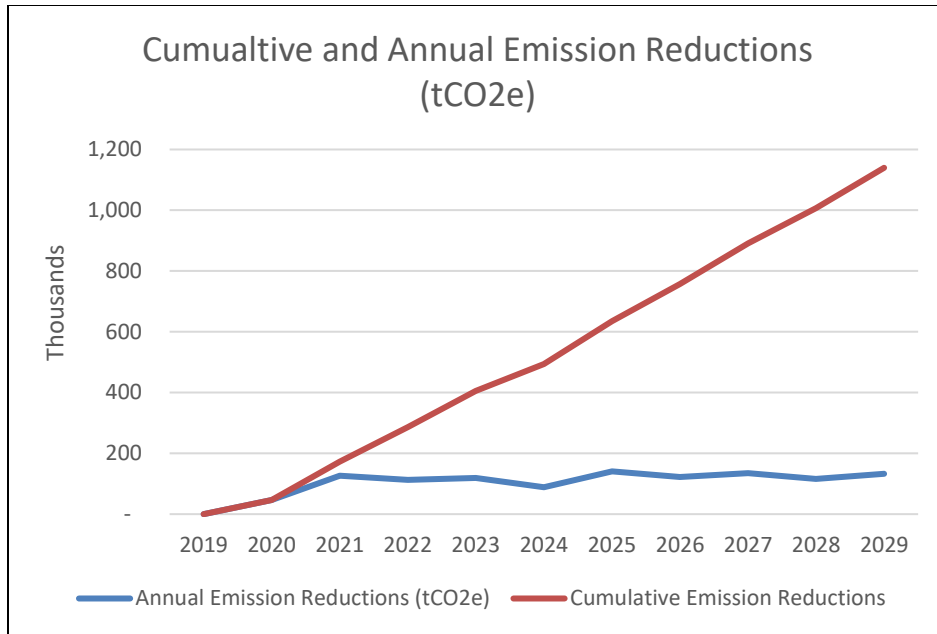

Figure 7-3: Emission reductions occur at a steady rate after gas delivery and use occurs.

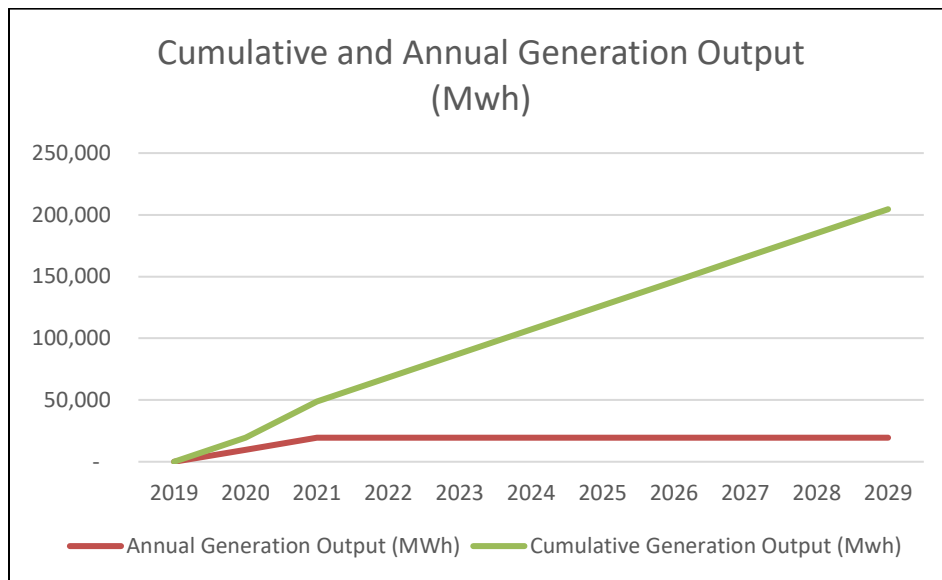

Figure 7-4: Annual generation output of 19,479 MWh occurs for entire project from 2021-2029.

8 Conclusions, Recommendations and Next Steps

The TengHui Mine pre-feasibility study was completed as part of an integrated Best Practices training program for the China ICE-CMM conducted from June through October 2018 with preparatory work, including initial data requests, beginning in January 2018. The training program involved three class-room training sessions in Shanxi province, China, a site visit to the TengHui Mine including visits to the surface and underground operations, and a surface visit to an operating CMM power project at the Duerping Mine near Taiyuan, China.

The mine currently drains methane using a combination of in-seam cross-panel boreholes and a combination of high-level and low-level cross-measure boreholes drilled above the longwall panel. The mine is also using cross-measure boreholes drilled from cross-heading piers. A new vacuum pump station drains CMM through high and low gathering systems. The sheer number of boreholes combined with the vacuum system are delivering methane concentrations within and below the explosive range. This not only creates a significant health and safety hazard within the mine, but also results in gas concentrations that cannot be used. All methane is currently vented, resulting in significant greenhouse gas emissions.

Following detailed review and discussion of the data provided by the TengHui Mine and a visit to the mine to observe the operations and gas drainage program, a gas reservoir simulation was conducted to simulate the gas recovery objectives of the mine employing directional boreholes in place of the cross-panel and cross-measure boreholes currently used. The results show that use of in-seam directional boreholes and HGB's drilled the length of each panel rather than across the panels will significantly increase the methane concentration in the gas drainage system. Although the total gas production will remain relatively the same as is produced today, the higher methane concentrations will be safer for the mine and will result in reduced greenhouse gas emissions because the methane will be at concentrations that allow for use. Estimated gas production was calculated by borehole and then applied to entire longwall panels in the No. 2 and No. 10 seams. A mine production plan was developed leading to a full mine gas production forecast which fed into the financial analysis.

A gob degasification approach that implements HGB's drilled from the mining seam to a derived height above the low-pressure side of the longwall panel, near the tailgate entry, is recommended. The mine should evaluate and change its longwall ventilation system practices as part of a mine-wide analysis to optimize both ventilation and degasification systems from an effectiveness and economic perspective.

This pre-feasibility study analyzes the costs and benefits of three scenarios: (1) the CMM power plant only; (2) the entire project including the proposed gas drainage program and the CMM power plant; and (3) the proposed gas drainage program only. The CMM power plant-only case was developed at the request of the TengHui Mine management because the implementation of the gas drainage program will be absorbed by the mining operation as part of its operations costs. For CMM utilization at the TengHui Mine, power generation was selected as the recommended option for the mine given market conditions and mine management priorities.

Because it is also important to understand the impact of the costs and cost savings of the proposed gas drainage program, financial analysis of the full project (case 2) and the net present value cost savings of the proposed drainage program by itself (case 3) are included in this report. In all three cases, the analyses show positive financial returns. For the power project-only case, the returns are very attractive due to the high price of power paid by the mine, the availability of the CMM subsidy, and the low cost of Chinese-

made gas gensets. The full project, case 2, also shows positive returns, although lower than the power plant-only case. As case 3 shows, the investment in directional drilling can be more cost-effective even without a surface project. However, if the TengHui Mine were to develop a CMM utilization project in concert with improving gas drainage, it could lead to net emission reductions of 1,481,616 tCO₂e over the life of the project using the optimal development scenario.

Based on the technical and financial analysis prepared for this study, it appears that a CMM power project at the TengHui Mine is feasible. A full-scale feasibility study for the proposed project(s) is recommended, which, at a minimum, should be prepared before any investment decision is made. To prepare a full feasibility study, the following next steps are suggested:

- Conduct a detailed engineering study, conduct additional monitoring of gas drainage and ventilation to provide a robust data set on which to evaluate project feasibility and identify important data gaps with respect to gas drainage and mine ventilation data and address;
- Secure additional geologic data to develop a more accurate gas resource assessment;
- Further refine the reservoir simulation and gas production forecast based on newly available or revised data;
- Contact drilling contractors to obtain estimates of drilling costs for directional drilled boreholes;
- Conduct additional market research and investigate more thoroughly all utilization options including power production to confirm the economic and technical feasibility of CMM-to-power and the viability of alternatives and their competitiveness with power generation;
- Conduct outreach to suppliers of equipment and services and compile equipment pricing, terms of sales and product specifications;
- Scope out engineering and construction requirements for the CMM plant;
- Develop a detailed project development and implementation schedule and determine internal costs for project development;
- Explore the markets for emission offsets, especially voluntary markets, to determine if the CO₂ offsets from the project can be sold and to establish relationships with offtakers, especially if the offtaker is interested in forward sales which will help generate cash up-front for the project;
- Markets for emission offsets will require the establishment of an emission baseline and development of a monitor, report, and verify (MRV) plan to create a formal system to credit emission reductions;
- Refine the financial analysis and develop a detailed project-specific model sufficient for internal or external financing entities.

9 References

- BP. (2018). *BP Statistical Review of World Energy*. Retrieved from BP: <https://www.bp.com/content/dam/bp/en/corporate/pdf/energy-economics/statistical-review/bp-stats-review-2018-coal.pdf>
- Britannica. (2018). *Shanxi*. Retrieved from Britannica: <https://www.britannica.com/place/Shanxi>
- CCII. (2016). *China Coal Information Institute, Summary of Guizhou and China CMM, Energy and Coal Markets*. Beijing, P.R. China.
- CCII. (2017). Status and Potential of AMM Project Development in China. Retrieved from CCII: <https://www.globalmethane.org/GMF2018/presentations/0417StatusandPotentialofAMMProjectDevelopmentinChina.pdf>
- China Daily. (2018). Coal-rich province goes 'green'. Retrieved from China Daily: <http://www.chinadaily.com.cn/a/201801/14/WS5a5ad496a3102c394518f145.html>
- Econotimes. (2016, March 10). Fitch: Higher China Coal-Bed Methane Subsidy Not Enough to Lift Industry. Retrieved from Econotimes: <http://www.econotimes.com/Fitch-Higher-China-CoalBed-Methane-Subsidy-Not-Enough-to-Lift-Industry-175912>
- EDF. (2017). The Progress of China's Carbon Market. Retrieved from Environmental Defense Fund: https://www.edf.org/sites/default/files/documents/The_Progress_of_Chinas_Carbon_Market_Development_English_Version.pdf
- EIA. (2015). *Energy Information Administration Beta*. Retrieved from Energy Information Administration: <http://www.eia.gov/beta/international/analysis.cfm?iso=CHN>
- GMI. (2015). The Experience with CMM Development: A Case Study Focusing on Policy from China. Retrieved from China Coal Information Institute: https://www.globalmethane.org/forum/presentations/coal/tuesday-session-2/Liuwenge_Experience_with_CMM_Development.pdf
- GMI. (2016). Coal Sector Updates in China. Retrieved from Global Methane Initiative Presentation, Geneva: [https://www.unece.org/fileadmin/DAM/energy/se/pp/coal/cmm/11cmm_gmi.cs_oct2016/2_GMI-Guihong, L. \(2016\). Coal reservoir characteristics and their controlling factors in the eastern Ordos basin in China. *International Journal of Mining Science and Technology*, 1051-1058. China_coal.pdf](https://www.unece.org/fileadmin/DAM/energy/se/pp/coal/cmm/11cmm_gmi.cs_oct2016/2_GMI-Guihong, L. (2016). Coal reservoir characteristics and their controlling factors in the eastern Ordos basin in China. International Journal of Mining Science and Technology, 1051-1058. China_coal.pdf)
- GMI. (2016). Coal Sector Updates in China. Retrieved from Global Methane Initiative Presentation, Geneva: [https://www.unece.org/fileadmin Finance Agency:](https://www.unece.org/fileadmin/Finance%20Agency)
- GZICCEP. (2011). *Guizhou Coal Mine Methane Resources and Comprehensive Utilization Options Final Report*. Guiyang, China.
- HKTDC. (2018). Shanxi: Market Profile. Retrieved from HKTDC: <http://china-trade-research.hktdc.com/business-news/article/Facts-and-Figures/Yuncheng-Shanxi-City-Information/ff/en/1/1X000000/1X0A1IMW.htm>

Huang, S. (2018, September 24). *China Coal Sector Update to the 27th Session of the Global Methane Initiative (GMI) Coal Subcommittee*. Retrieved from https://www.unece.org/fileadmin/DAM/energy/se/pp/coal/cmm/13cmm_sept2018/24_September_GMI/4_CHINA.pdf

ICE. (2018, December 10). ICE Futures Europe: CER Futures. Retrieved from <https://www.theice.com/products/814666/CER-Futures/data?marketId=5878676&span=1>

ICAE. (2016). Provincial energy consumption and emission projection- Shanxi Case study. Retrieved from the 8th International Conference on Applied Energy: <https://www.sciencedirect.com/science/article/pii/S1876610217306689>

IPCC. (2007). *Climate Change 2007: Synthesis Report*. Contribution of Working Groups I, II and III to the Fourth Assessment Report of the Intergovernmental Panel on Climate Change [Core Writing Team, Pachauri, R.K and Reisinger, A. (eds.)]. IPCC, Geneva, Switzerland, 104 pp. https://www.ipcc.ch/site/assets/uploads/2018/02/ar4_syr_full_report.pdf

IPCC. (2013). Summary for Policymakers. In: *Climate Change 2013: The Physical Science Basis*. Contribution of Working Group I to the Fifth Assessment Report of the Intergovernmental Panel on Climate Change. Geneva, Switzerland: Intergovernmental Panel on Climate Change. Retrieved from https://www.ipcc.ch/pdf/assessment-report/ar5/wg1/WG1AR5_SPM_FINAL.pdf

NRDC. (2016). *The 13th Five-Year Plan for Energy Development*. NRDC.

NSBSSC. (2018). Statistical Communiqué of 2017 National Economic and Social Development of Shanxi Province. Retrieved from National Survey Bureau Shanxi Survey Corps: http://www.linfen.gov.cn/gov/article_214871.html

Ripley. (2018). "Carbon Offset Markets and U.S. CMM Project Development". Presentation of the American Carbon Registry for the U.S. Environmental Protection Agency Coalbed Methane Outreach Program Webinar.

SCCG. (2018). *Overview*. Retrieved from <http://www.sxcc.com.cn/gaikuang.jhtml>

U.S. Geological Survey. (2014). *USGS Compilation of Geographic Information System (GIS) Data Representing Coals Mines and Coal-Bearing Areas in China. Open File Report 2-14-1219*. Reston, Virginia USA: U.S. Department of the Interior, U.S. Geological Survey.

US EIA. (2015). *China International Analysis*.

USEPA. (2015). *EPA Country CMM Profiles*. Retrieved from EPA: http://www3.epa.gov/cmop/docs/cmm_country_profiles/Toolsres_coal_overview_ch7.pdf

USEPA. (2015a). Energy Markets in China and the Outlook for CMM Project Development in Anhui, Chongqing, Henan, Inner Mongolia, and Guizhou Provinces. Retrieved from EPA: https://www.epa.gov/sites/production/files/2016-03/documents/2014_coalchinaenergymarket_fullreport.pdf

Wenge, L. (2016). The Experience with CMM Development: A Case Study Focusing on Policy from China. *Global Methane Forum*. Washington D.C. USA: Global Methane Forum. Retrieved from

https://www.globalmethane.org/forum/presentations/coal/tuesday-session-2/Liuwenge_Experience_with_CMM_Development.pdf

XFA. (2017). Shanxi integrates gas assets, 1st provincial gas company to set up. Retrieved from Xinhua Finance Agency:

Yuguang, Z. (2004). Preliminary Analysis of Coal Seam Gas of Huachu Pit at Liuzhi Coal Field. *Guizhou Geology*, 21(2), 109-11.